



MINISTERUL EDUCAȚIEI AL REPUBLICII MOLDOVA

# English for You and Me

Afanasie Manic  
Tatiana Musteața  
Larisa Glavan  
Timothy Schneider

PUPIL'S BOOK

FORM **7**

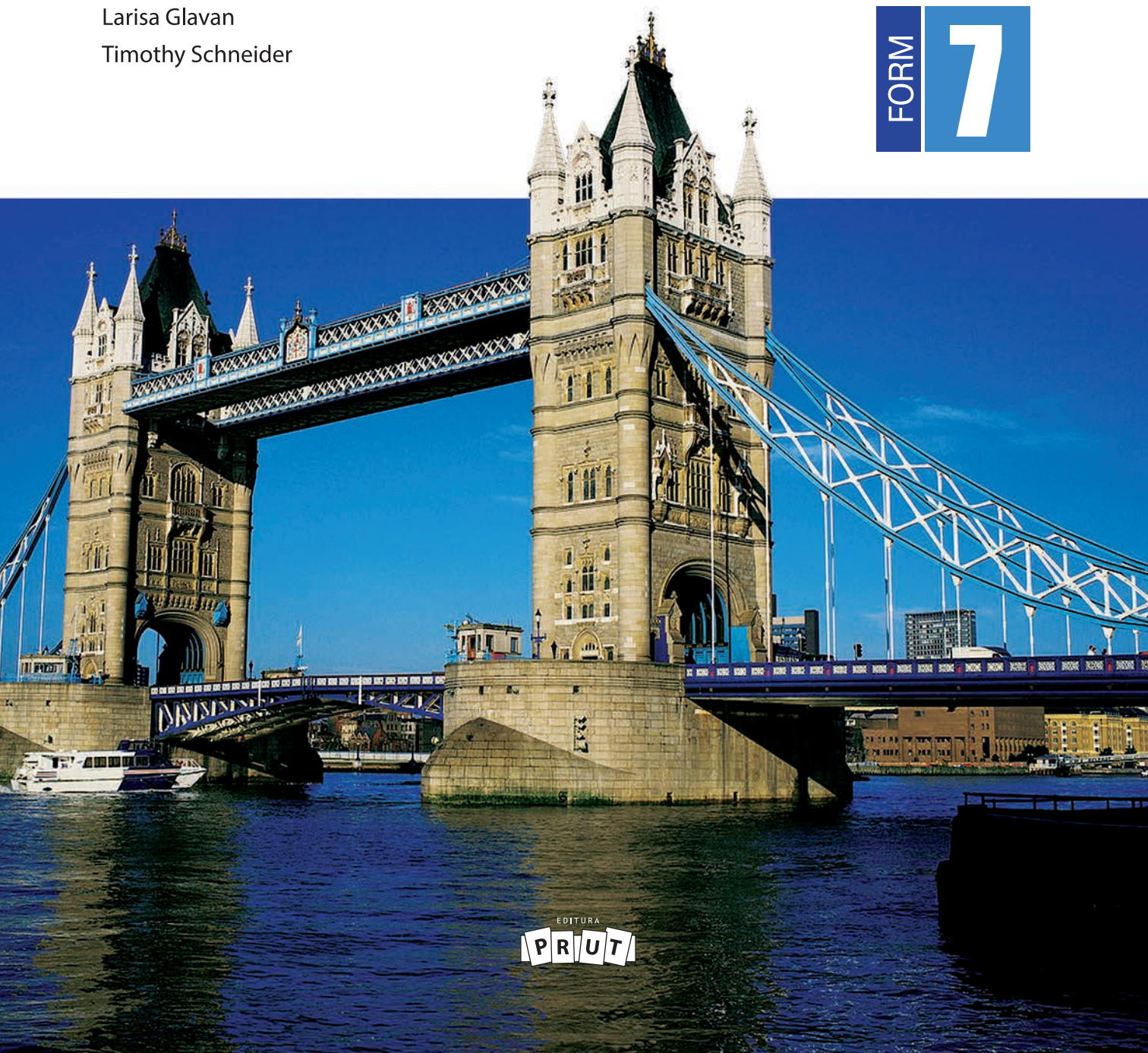

EDITURA  
**PRUT**

MINISTERUL EDUCAȚIEI AL REPUBLICII MOLDOVA

---

# English for You and Me

PUPIL'S BOOK

Afanasie Manic

Tatiana Musteața

Larisa Glavan

Timothy Schneider



Manualul a fost aprobat pentru reeditare prin ordinul Ministrului Educației al Republicii Moldova nr. 787 din 29 iulie 2015.

Manualul este elaborat conform curriculumului disciplinar și finanțat din sursele Fondului Special pentru Manuale.

Acest manual este proprietatea Ministerului Educației al Republicii Moldova.

| Școala .....      |                              |             |                     |              |
|-------------------|------------------------------|-------------|---------------------|--------------|
| Manualul nr ..... |                              |             |                     |              |
| Anul de folosire  | Numele și prenumele elevului | Anul școlar | Aspectul manualului |              |
|                   |                              |             | la primire          | la returnare |
|                   |                              |             |                     |              |
|                   |                              |             |                     |              |
|                   |                              |             |                     |              |
|                   |                              |             |                     |              |
|                   |                              |             |                     |              |

- Dirigințele clasei trebuie să controleze dacă numele elevului este scris corect.
- Elevul nu va face nici un fel de însemnări în manual.
- Aspectul manualului (la primire și la returnare) se va aprecia: *nou, bun, satisfăcător, nesatisfăcător*.

Comisia de evaluare:

*Cornelia Gîrlea, lector, Liceul Teoretic „Mircea Eliade”, Chișinău*

*Ecaterina Albu, profesoară, grad didactic superior, Liceul de Creativitate și Inventică „Prometeu-Prim”, Chișinău*

*Elena Bogoeva, profesoară, grad didactic superior, Liceul Teoretic „Petru Movilă”, Chișinău*

*Svetlana Lungu, profesoară, grad didactic superior, Liceul Teoretic „Mihai Eminescu”, Chișinău*

Referent: *Alexander Hollinger, doctor conferențiar, România*

Redactor: *Timothy Schneider, MA in English, University of Kansas, USA*

Ilustrații: *Iulia Grădinar-Șobari*

Coperta: *Sergiu Stanciu*

Paginare computerizată: *Adrian Grosu, Denis Grădinar*

© *Prut Internațional*, 2015

© *Afanasie Manic, Tatiana Musteață, Larisa Glavan, Timothy Schneider*, 2015

Editura se obligă să achite deținătorilor de copyright, care încă nu au fost contactați, costurile de reproducere a imaginilor folosite în prezenta ediție.

Editura Prut Internațional, str. Alba Iulia nr. 23, bl. 1A, Chișinău, MD 2051

Tel./fax: (+373 22) 74 93 18; tel.: (+373 22) 75 18 74; [www.edituraprut.md](http://www.edituraprut.md); e-mail: [editura@prut.ro](mailto:editura@prut.ro)

CZU 811.111(075.3)

E 57

Imprimat la Combinatul Poligrafic. Comanda nr. 50764

ISBN 978-9975-54-214-2

OVERVIEW OF CONTENTS

|                                    | Topic                              | Communicative area  | Vocabulary  | Grammar   | Page |
|------------------------------------|------------------------------------|---|---|---|------|
| <b>Pronunciation Key</b>           |                                    |   |   |   |      |
| <b>UNIT I. Appearance</b>          | Lesson 1. Head and Face            | Parts of the body (face, hair, eyes, nose).                           | Words referring to people's appearance.               | The Possessive Case   | 6    |
|                                    | Lesson 2. Feet and Legs            | Parts of the body (legs and feet).                                    | Words referring to people's appearance. Action verbs. | Nouns having only the singular or only the plural   | 9    |
|                                    | Lesson 3. Hand and Arm             | Parts of the body (arms and hands).                                   | Talking about people's appearance.                    | Simple Tenses Passive (Revision). The Present Progressive Passive   | 11   |
|                                    | Lesson 4. Clothing                 | Garments and fashion.   | Vocabulary on the topic.                              | Noun Compounds<br>Noun Substitutes  | 15   |
|                                    | Lesson 5. Footwear                 | Footwear diversity.   | Specific vocabulary for the topic Footwear.           | Reported speech – Simple Tenses   | 18   |
| <b>Round Up 1</b>                  |                                    |   |   |   | 22   |
| <b>UNIT II. Family and friends</b> | Lesson 1. Family                   | Family relations.   | Words denoting family relations.                      | Clauses of time and condition after conjunctions: if, when, after, before, as soon as, till, until, in case | 24   |
|                                    | Lesson 2. Family Traditions        | Observing family traditions.  | Word field: traditions and customs.                   | Reported Speech – Progressive Tenses  | 27   |
|                                    | Lesson 3. From the Oven            | Baked goods   | Recipes, ingredients.                                 | Reported Speech – Imperative sentences  | 30   |
|                                    | Lesson 4. Holiday Table            | Laying a holiday table  | Word field: holiday table                             | Reported Speech – Perfect Tenses  | 33   |
|                                    | Lesson 5. Friends                  | Friends and friendship.   | Vocabulary on the topic.                              |   | 35   |
| <b>Round Up 2</b>                  |                                    |   |   |   | 38   |
| <b>UNIT III. People and places</b> | Lesson 1. The United Kingdom       | The geographical position and political system of the United Kingdom. | Word field: geographical names.                       | Geographical names with or without “the”  | 40   |
|                                    | Lesson 2. Historical Personalities | Historical figures of Great Britain and Moldova.                      | Vocabulary on the topic.                              | Polysemy  | 43   |
|                                    | Lesson 3. Seaport Cities           | Seaport cities.   | Vocabulary referring to geographical names.           | Reported speech – General Truth   | 46   |
|                                    | Lesson 4. Housing                  | Types of houses.  | Words denoting types of houses.                       | Present Perfect Progressive   | 49   |
|                                    | Lesson 5. Children's Room          | Rooms and furniture.  | Names of furniture and fittings.                      | Past Perfect Progressive  | 52   |
| <b>Round Up 3</b>                  |                                    |   |   |   | 54   |

OVERVIEW OF CONTENTS

|                           | Topic                              | Communicative area                              | Vocabulary  | Grammar   | Page |
|---------------------------|------------------------------------|---|---|---|------|
| UNIT IV. School           | Lesson 1. Schooling                | Education in Moldova                            | Words denoting school education.                                      | Words with figurative meanings  | 56   |
|                           | Lesson 2. English Classroom        | Describing an English Classroom.                | Tips for improving English.   | Subjunctive Mood after “wish”   | 59   |
|                           | Lesson 3. English Speaking-Club    | Out-of-class activities. The goals of the club. | Words describing an out-of-class activity.                            | Subjunctive Mood after “if”   | 62   |
|                           | Lesson 4. Education through Film   | Talking about Cinema at School.                 | Word field: cinema.   | What and Which  | 66   |
|                           | Lesson 5. Mother’s Day             | Speaking about love to mother. Feelings.        | Vocabulary referring to the topic.                                    | “Do” as a substitute of the main verb   | 69   |
|                           | Round Up 4                         |   |   |   | 72   |
| UNIT V. Outside of school | Lesson 1. Arts and Crafts          | Artisanship.                                    | Names of tools and artisanship articles.                              | The verbs “do” and “make”   | 74   |
|                           | Lesson 2. Jobs                     | Occupations and professions.                    | Names of jobs.  | either; either... or ...; neither; neither... nor ...   | 77   |
|                           | Lesson 3. Sports and Games         | Sports and games. The importance of sports.     | Names of sports.  | Subjunctive Mood after verbs expressing suggestions, orders, demands  | 80   |
|                           | Lesson 4. Compassion and Empathy   | Caring about people with physical deficiencies. | Vocabulary referring to people with physical and mental deficiencies. | Homonyms, Homophones, Homographs  | 84   |
|                           | Lesson 5. Flora and Fauna          | Nature.   | Flora and fauna vocabulary.   | Exclamations: What... ! How... !  | 87   |
|                           | Lesson 6. Travelling               | Travelling. Arranging a trip.                   | Trip describing vocabulary.   | The meaning of “naturally” depending on its place in the sentence.<br>... and, what was worse ...<br>..., which annoyed ... | 91   |
|                           | Round Up 5                         |   |   |   | 94   |
|                           | Check your knowledge .....         |   |   |   | 96   |
|                           | Supplement                         |   |   |   |      |
|                           | a) Scripts.....                    |   |   |   | 100  |
|                           | b) Back to Grammar .....           |   |   |   | 107  |
|                           | c) Improve your knowledge .....    |   |   |   | 121  |
|                           | d) English Speaking Countries..... |   |   |   | 125  |
|                           | e) Additional reading.....         |   |   |   | 130  |
|                           | Irregular verbs.....               |   |   |   | 132  |
|                           | Vocabulary .....                   |   |   |   | 134  |

PRONUNCIATION KEY

| CONSONANTS |          |   | VOWELS |           |  |
|------------|----------|---|--------|-----------|--|
| symbol     | key word | other common spellings                      | symbol | key word  | other common spellings                         |
| p          | pat      | happen                                      | ʌ      | nut       | come, flood                                    |
| b          | big      | bubble                                      | ɑ:     | farm      | palm, rather, draught, hearth                  |
| d          | duty     | played, addition                            | ɒ      | not       | wash, cough                                    |
| t          | ten      | hotter, asked                               | ɔ:     | north     | haughty, abroad, force, paw, tall, court, door |
| k          | kettle   | cut, black, quite, scientific               | ɪ      | big       | build, women, message, myth                    |
| g          | gloomy   | digger, ghost                               | i:     | deep      | eat, ceiling, me, niece                        |
| dʒ         | just     | rage, graduate, soldier                     | ʊ      | push      | look, could, woman                             |
| tʃ         | chess    | future, catch, question                     | u:     | tooth     | movement, soup, brutal, glue, drew, cruise     |
| f          | fun      | biography, rough, half, coffee              | æ      | cat       | plaid, plait                                   |
| v          | verb     | of  | e      | red       | weather, many, friend, said                    |
| θ          | thick    |   | ə      | doctor    | writer, children, dollar                       |
| ð          | though   |   | ɜ:     | girl      | work, herb, turn, earl, journey                |
| s          | spoon    | psychologist, mass, scenery, fasten, centre | aɪ     | nice      | fly, right, rye, quite, pie                    |
| z          | zoo      | boys, exact, dizzy                          | aʊ     | down      | ploughman, spouse                              |
| ʃ          | wash     | version, surely, champagne                  | eɪ     | take      | plain, tray, rein, prey, steak, reign          |
| ʒ          | measure  | revision, regime                            | əʊ     | nose      | know, foe, boast, poultry                      |
| h          | hen      | whom  | ɔɪ     | toy       | noise  |
| l          | lead     | small, nettle                               | eə     | their     | fair, there, hare                              |
| m          | map      | tomb, palm, summer                          | ɪə     | near      | deer, mere, fierce                             |
| n          | run      | beginner, knee, sign                        | ʊə     | tourist   | surely, moor                                   |
| ŋ          | sing     | link  | aɪə    | liar      |  |
| r          | room     | carry, wrong, rheumatic                     | aʊə    | power     |  |
| j          | yes      | opinion, knew, unite                        | ɔɪə    | destroyer |  |
| w          | warm     | what, quite                                 | eɪə    | layer     |  |
|            |          |   | əʊə    | mower     |  |

**I Pronunciation**

*Read as quickly as you can:*

I spy with my little eye

a fly on a pie

by a dry piece of bread.

I spy with my little eye

a guy in the sky

who might fall on his head.



*“Appearances are often deceiving.”*

*Aesop*

**II Conversational Formulas**

*Which of the phrases below will you use in certain situations when greeting someone?*



- Hello, how are you?
- How's life?
- What's new?
- How are things going?
- How've you been?
- What have you been up to?
- How was your summer?



- I'm great. Thank you for asking.
- Not bad. And you?
- Not much.
- Things are going pretty well.
- I've been great!
- I've been busy with...
- It was terrific. How about you?

**III Discussion Points**

- 1 *How do we recognize people when we see them on the street?*
- 2 *What would happen if everyone looked the same?*
- 3 *What words would you use to describe the face of the girl in the picture. (see the top of the page)*
- 4 *Say how you understand the lesson quote.*

**IV Vocabulary**

- 1 *Read and pronounce the words and phrases. Use a dictionary to find their meaning.*

|                   |         |                           |      |                     |                                   |
|-------------------|---------|---------------------------|------|---------------------|-----------------------------------|
| eye -             | eyelash | nose -                    | flat | hair -              | straight                          |
| eyebrow           | iris    | broad                     | snub | wavy                | bald                              |
| eyelid            | pupil   | long                      |      | curly               | plaited (Br. E.)/braided (Am. E.) |
| to get a hair cut |         | to have one's hair styled |      | to style one's hair |                                   |

- 2 *Fill in the blanks, using the new vocabulary.*

- a) Sarah has large eyes with long ...
- b) Grandfather has thick ... and has to trim them often.
- c) Mother and I have small noses. People say they are ...
- d) You look great! Did you ... your ... ..?
- e) I heard that Ionela has to use an iron to make her hair ...
- f) Uncle Tudor has lost his hair. He is completely ...
- g) Most of my family has ..., thin noses that measure 6cm or more.
- h) Tom is at the barber. He's ... ..

- 3 *Describe a classmate, using 6 words from the new vocabulary.*

**V Reading**

**1** Read the text and say if the girl's appearance in the picture corresponds to the one described in the text.

**A VISIT TO THE COUNTRY**



Last summer Sandu decided to spend his vacation at his cousin's who lives in the North of Moldova. It was at the beginning of July when he left for the village of Sofia. The weather was fantastic and the surroundings were full of greenery. The beauty of the countryside impressed him very much. When meeting his cousin Lucia at the railway station, he was surprised by her change. It was two years ago when he saw her last. Instead of a short, clumsy child, now there was a different person in front of him: a tall, graceful young girl. He couldn't help

noticing her big blue eyes with long, thick eyelashes and dark eyebrows. Most of all, he liked her long, wavy hair that shone in the sun. She was the sort of person who seemed to attract everybody, especially when she smiled.

His aunt's house wasn't far from the station, so it didn't take them long to get there. When they approached the house, his aunt greeted him. Sandu was happy to see her. He stayed at his aunt Maria's for two weeks. He had a good opportunity to learn a lot of things about life on the farm and make new friends.



**2** Answer the questions about the text.

- a) Where did Sandu decide to spend his holiday?
- b) What was the weather like?
- c) When did Sandu see his cousin last?
- d) Who met him at the station?
- e) How long did he stay there?
- f) Why was he surprised when he saw his cousin?

**3** Find antonyms for the following words:

- |        |       |       |      |       |        |
|--------|-------|-------|------|-------|--------|
| winter | first | die   | end  | dull  | empty  |
| ugly   | thin  | short | thin | light | behind |

**VI Grammar**

**Remember:**

| The Possessive Case   |   |
|---|---|
| Analytical Possessive Case  | Synthetical Possessive Case   |
| of  | 's  |
| 1. The face of my granny is wrinkled.<br>5. The forehead of my dad is high.<br>6. The eyes of the girl dance and twinkle. | My granny's face is wrinkled.<br>My dad's forehead is high.<br>The girl's eyes dance and twinkle. |

**1** Look at the text and find sentences that use the Possessive Case.



**2** Change the APC sentences to SPC sentences.

- a) The hair of my mother is wavy and beautiful.  
 b) The nose of my father is long.  
 c) The eyes of the boy change colour with his moods.  
 d) The eyelashes of my sister are thick.  
 e) The eyebrows of my uncle are bushy.  
 f) The nose of my friend is straight.  
 g) The hair of my brother looks wild and curly.  
 h) The face of the woman was intelligent and kind.

**VII Writing**

- 1** Write a short paragraph describing the eyes, nose and hair of two people in your family, or of two friends.  
**2** Using the words from the lesson, write a description of two of the people shown in the pictures below. (The network below will help you).

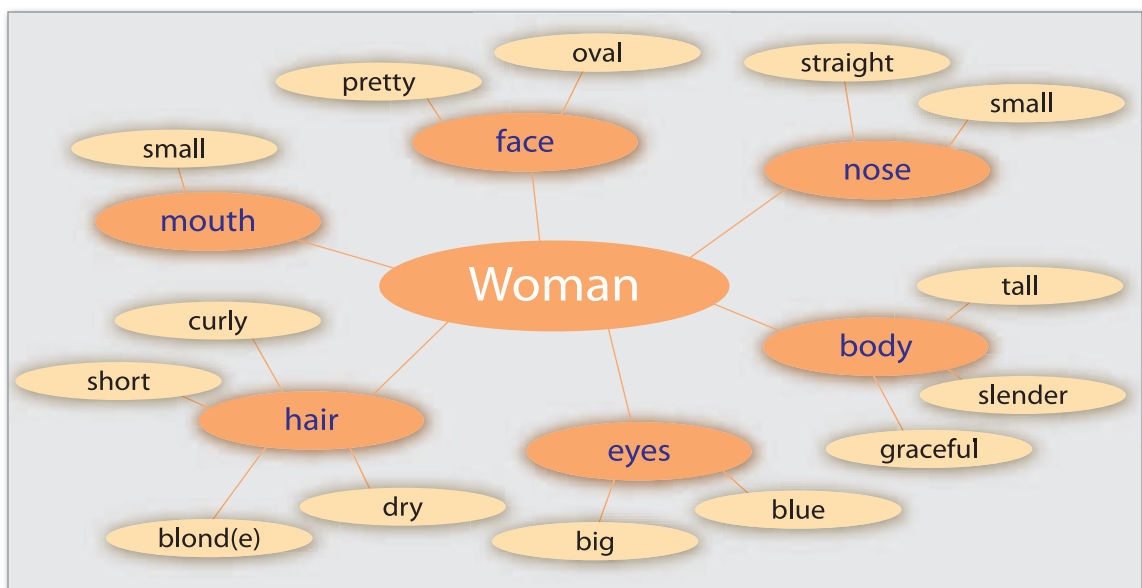

**I Pronunciation**

*Read as quickly as you can without making mistakes.*

Upon two feet  
the fleeting fighter fled.

But, where did he flee  
this two-footed fighter  
as down the road he sped?



*“You have brains in your head. You have feet in your shoes. You can steer yourself in any direction you choose.”*

*Dr. Seuss*

**II Discussion Points**

**1** *In pairs, match the following idioms with their definitions, then make up some sentences that you can share with the rest of the class. Use the computer if necessary.*

- |                                      |  |
|--------------------------------------|--|
| 1. to bring someone to heel          | a) to know someone’s weakness          |
| 2. to drag one’s feet                | b) to be alert                         |
| 3. to cool one’s heels               | c) to make someone obey                |
| 4. to find someone’s Achilles’s heel | d) to calm down or pause before acting |
| 5. to be on one’s toes               | e) to begin in the right way           |
| 6. to start off on the right foot    | f) to delay                            |

**2** *As a class, share your thoughts about the lesson quote. What does it mean to you?*

**III Vocabulary**

**1** *Read and pronounce the words and phrases. Use a dictionary to find their meaning.*

|            |           |             |             |
|------------|-----------|-------------|-------------|
| Nouns      | 1 shin    | 4 thigh     | 7 arch      |
|            | 2 knee    | 5 heel      | 8 ankle     |
|            | 3 sole    | 6 calf      | 9 toe       |
| Verbs      | to kick   | to jog      | to tiptoe   |
|            | to step   | to skip     | to scratch  |
|            | to bruise | to sprain   |             |
| Adjectives | crooked   | long-legged | flat-footed |

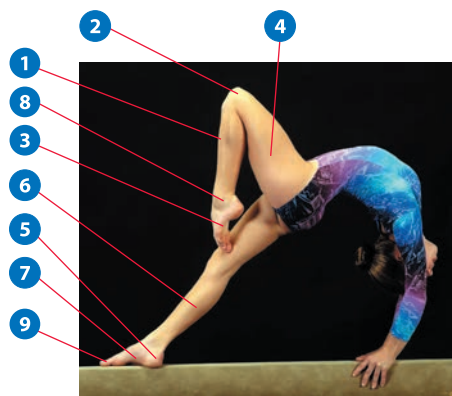

**2** *Fill in the blanks, using the new vocabulary.*

- |  |   |
|--|---|
| a) Mark has trouble walking for a long distance. He is ...   | f) Their little baby has 10 little ... and 10 little fingers. |
| b) Mom, did you notice that your big toe is bent and ... ?   | g) Eleanor ... her ankle while she was skating.               |
| c) The little girl was happily ... down the street.          | h) Ow! I just bruised my ... on the corner of the desk.       |
| d) The rock in her shoe hurt the ... of her foot.            |   |
| e) Tommy has to wear special shoes because he has a high ... |   |

**IV Reading**

**1** *Read the text and say if you would like a vacation like this.*

**MY ADVENTURES IN THE MOUNTAINS**

As a special prize for getting high marks in school this year, my mum and dad decided to take me on a holiday for a week in the mountains. They didn’t want to stay in a hotel with lots of people, so we decided to go camping. We also didn’t want to drive too far, so we went to the Carpathians. I really had a great time,

though hiking in the mountains was more difficult than I thought.

On the first day of the trip, I slipped on some loose<sup>1</sup> rocks and sprained my ankle. While limping<sup>2</sup> back to camp, I fell and bruised my shin. I hadn't been hiking for a while, so I also got blisters<sup>3</sup> on my heels and somehow I cut the sole of my foot on a sharp rock while I was checking on my tired feet. Wow, did I sleep well that night!

On the second day, I told my parents that I had to climb the beautiful mountain peak that was nearby.

<sup>1</sup> loose [lu:s] adj. – nefixat

<sup>2</sup> to limp [lɪmp] v. – a șchiopăta

<sup>3</sup> blister ['blɪstə] n. – bășică

This time, Dad went with me, and while I was fine, he stepped on some wet plants, slipped, tore his pants and scratched his thigh. My dad is long-legged and tall, so it was difficult to get him down the mountain with his bad leg. He had to use me for support.

On our last night, it was so beautiful that I quietly left the tent and tiptoed away from the camp to look at the stars. I heard something in the dark. When it touched my right shin, I kicked it and it ran away. I never found out what it was.

Besides all of our cuts and bruises, we all agreed that we had a great time. I can't wait to go again next year.

## 2 Answer the questions about the text.

- a) Why did the boy's parents take him on a camping trip?  
 b) Why didn't they want to stay in a hotel?  
 c) How safe was the trip for the family? Why do you think so?  
 d) Why did the boy leave his camp on the last night?  
 e) What do you think touched his leg?

## 3 Find synonyms for the following words:

|        |            |          |       |      |                          |
|--------|------------|----------|-------|------|--------------------------|
| award  | outing     | terrific | close | help | to escape                |
| lovely | unordinary | to go up | hard  | top  | walking in the mountains |

## V Grammar

### Remember:

| Nouns having only the Singular  | Nouns having only the Plural  |
|---|---|
| news, money, mathematics<br>information, advice, physics<br>dominoes, darts, football<br>linguistics, billiards | jeans, trousers,<br>glasses, scissors,<br>people, spectacles,<br>police, scales |

## 1 Choose the right pronoun or verb form.

- a) Gymnastics are/is a sport for people with strong legs.  
 b) This/These jeans are/is very comfortable.  
 c) Is/Are that/those glasses yours?  
 d) Billiards is/are played all over the world.  
 e) Is/Are that/those the trousers you tore a hole in?  
 f) The scissors are/is on the table.

## 2 Make up sentences using the words in the grammar box.

## VI Writing

### 1 Write a short paragraph describing your feet and legs. E.g. My legs are long and straight.

### 2 Abraham Lincoln said, "Put your feet in the right place, and stand firm." Write a paragraph with 50 words to explain his quote.

**I Pronunciation**

*Read as quickly as you can without making mistakes.*

Felicia fries finger food.  
 She fries it up by hand.  
 Felicia fries finger food  
 And sells it in her stand.

**II Discussion Points**

**1** *In pairs, match the following idioms with their definitions, then make up some sentences that you can discuss with the rest of the class.*

- 1. to give a hand to someone
- 2. to bite the hand that feeds you
- 3. to go hand in hand
- 4. to experience first hand
- 5. to be handy
- 6. to live hand to mouth
- 7. to be heavy handed

- a) to be very useful or nearby
- b) hardly able to buy necessities like food
- c) to applaud or help someone
- d) to be very strict or severe with someone
- e) do harm to someone who has been kind to you
- f) to work well together or fit together
- g) to witness or experience something by yourself

**2** *Discuss what the lesson quote means to you.*

**3** *How are human hands different from animals'? How do they help us do more things?*

**4** *How can human hands help/hurt other people or animals?*

**5** *Find equivalents in your mother tongue to the following idioms:*

- a) to elbow one's way;
- b) not to lift a finger.

**III Vocabulary**

**1** *Read and pronounce the words and phrases. Use a dictionary to find their meaning.*

|            |  |                        |
|------------|--|------------------------|
| Nouns      | 1 wrist  | 6 ring-finger          |
|            | 2 palm   | 7 little/pinkie finger |
|            | 3 thumb  | 8 knuckles             |
|            | 4 index/fore-finger  | 9 fist                 |
|            | 5 middle-finger  |                        |
| Verbs      | to wave  | to touch               |
|            | to fold  | to hit / strike        |
|            | to pat   | to caress / to pet     |
|            | to embrace / to hug  |                        |
| Adjectives | rough  | smooth                 |
|            | to hit – hit – hit<br>to strike – struck – struck (stricken) |                        |

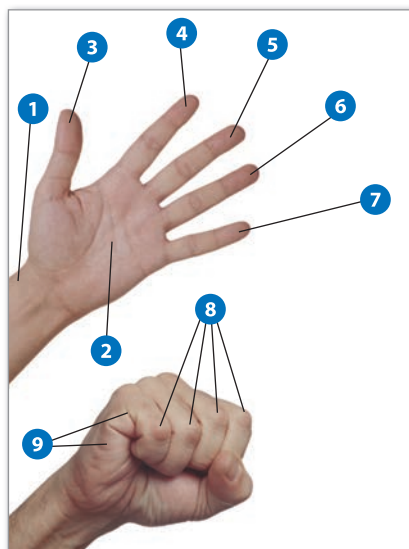

*“The final forming of a person’s character lies in his own hands.”*

*Anne Frank*



**2** *Fill in the blanks, using the new vocabulary.*

- a) If you want a nice dog, be sure to ... it everyday.  
 b) Sylvia must be married. She has a big ring on her ... ..  
 c) We use our ... finger to point to things.  
 d) Ralph got angry and ... the wall with his ...  
 e) Please don't ... the paint; it's still wet.  
 f) If your left ... itches, you may get some money.  
 g) Uncle Bob used to ... me on the head.  
 h) The cowboy's hands were ... from hard work.  
 i) Shall we ... at the President as he drives by?

**IV** *Reading*

**1** *Read the text to learn how to spell 'I love you' in American Sign Language.*



Imagine you couldn't hear what people were saying around you. This is what it means to be deaf. Deaf people have learned to talk by using their hands to make individual letters or symbols for whole words and ideas. Sometimes, a new word is made that doesn't have a symbol or sign. Similarly, people's names usually don't have a sign. In these cases, deaf people spell (letter by letter) the word they want to say, and they make these letters with their hands and fingers.

Let's try to explain how to spell 'I love you' using American Sign Language or ASL. Most of the letters in ASL are made by turning your palm toward the person you are speaking to. Generally, if you are right-handed, you would use your right hand to finger spell a word.

The first letter 'I' is made by folding your first three fingers under your thumb, and letting your little finger stick straight up.

The letter 'L' is formed by making an 'L' shape with your index finger and your thumb. Your other three



fingers are folded down. 'O' is made by touching your four fingers to your thumb to make an 'O' - like shape. The letter 'V' is easy. You hold up your fore-finger and your middle finger in the shape of a 'V' while your ring and pinkie fingers are folded under your thumb. It looks like a 'peace' sign. Finally, to make the 'E' we



bend all of our fingers at the knuckles and fold our thumb underneath them.

The letter 'Y' is also easy. Just fold your index, middle and ring fingers while leaving the thumb and little finger up. You already know how to make an 'O' by

now, and the last letter is 'U'. To make a 'U' hold your fore-finger and middle finger up straight. Do not separate them. Fold your ring finger and little finger under your thumb.

Now you can spell 'I love you' in sign language.

**2 Say whether the following sentences are true (T) or false (F).**

- a) People spell words with their hands when they can't see.
- b) Some words in sign language don't have a sign.
- c) We make the letter 'V' by folding all our fingers under our thumb.
- d) People's names usually don't have a sign in sign language.
- e) Most spelling is done in sign language with the palm facing the person you're speaking to.
- f) Deaf people have no way to communicate.

**3 Unscramble the sentences from the text.**

your / finger / ring / Fold / and / finger / under / little / thumb / your.  
 'E' / bend / the / all / make / fingers / knuckles / at / the / We / to / letter / the.  
 easy / letter / The / 'V' / is.  
 people / learned / have / Deaf / talk / their / using / to / hands.

**V Grammar**

**Revision:**

**PASSIVE VOICE**

We use **Passive Voice** when we **don't know who does the action, or it is not important who does it.**

| ACTIVE  | PASSIVE  |
|---|--|
| <b>Present Simple (am / are / is + V<sub>3</sub> / V<sub>ed</sub>)</b>  |  |
| <i>I <b>do</b> my hair every day.</i>                                   | <i>My hair <b>is done</b> every day.</i>                     |
| <b>Past Simple (was / were + V<sub>3</sub> / V<sub>ed</sub>)</b>        |  |
| <i>He <b>bruised</b> his knees badly yesterday.</i>                     | <i>His knees <b>were</b> badly <b>bruised</b> yesterday.</i> |
| <b>Future Simple (will / shall be + V<sub>3</sub> / V<sub>ed</sub>)</b> |  |
| <i>She <b>will dye</b> her hair tomorrow.</i>                           | <i>Her hair <b>will be dyed</b> tomorrow.</i>                |

**1 Look at the text and find sentences that use the Passive Voice.**

**2 Change the sentences below to the Passive Voice.**

- a) Last Sunday, the cat scratched Nick's hands very badly.
- b) Mother usually hugs us when we come home from school.
- c) We shall need all hands to help us finish the job.
- d) When did Peter cut his finger?
- e) Christina didn't pet the dog.
- f) The girl touched the computer screen.

**Remember:****THE PRESENT PROGRESSIVE PASSIVE**

| <b>Active voice: to be + V. ing</b>   | <b>Passive Voice: to be + being + V<sub>3</sub></b>                                     |
|---|---|
| The workers <b>are building</b> a new house now.<br><b>Are</b> the workers <b>building</b> a new house now? | A new house <b>is being built</b> now.<br><b>Is</b> a new house <b>being built</b> now? |
| Mom <b>is cooking</b> dinner now.   | Dinner <b>is being cooked</b> now.  |
| Mom <b>is not cooking</b> pies now.   | Pies <b>are not being cooked</b> now.   |

**3 Using the phrases below, say what is being done now.**

- |                                      |                      |
|--------------------------------------|----------------------|
| a) So much class work (to do)        | - at the lesson      |
| b) Different games (to play)         | - in the school yard |
| c) So many goods (to buy/sell)       | - in the shop        |
| d) Fruits and vegetables (to gather) | - in the garden      |

**4 Change into passive.**

- |   |                                       |
|---|---------------------------------------|
| a) The hairdresser is styling Ann's hair. | d) Meg is polishing her nails.        |
| b) Mum is bathing the baby.               | e) Is the child embracing his mother? |
| c) Paul is washing his hands.             | f) Frank is not pushing his bike.     |

**VI Writing****1 Do exercise 4 from Grammar in writing.****2 Give the "-ing" form of the verbs in writing.**

- |                 |                |
|-----------------|----------------|
| a) to wave -    | f) to pat -    |
| b) to fold -    | f) to touch -  |
| c) to embrace - | f) to caress - |
| d) to hug -     | f) to pet -    |
| e) to hit -     | f) to hand -   |
| f) to strike -  | f) to shake -  |

**3 What does your mother do with her hands? Write a paragraph of 50 words. Use the vocabulary to help.****VII Additional Information***Believe It or Not*

- The Paraya Indians of the Amazon Valley can speak without moving their lips. Sounds are formed with the help of the tongue and go through the nose instead of the mouth.
- The men and women of this tribe speak two different dialects and understand each other with a great difficulty.

**I Pronunciation**

*Read as quickly as you can without making mistakes.*

Ten tiny tailors tailored ten tiny trim coats.  
They tailored all night through.  
Then they trimmed the trim of the trim coats.  
What more could tiny tailors do?



*“The tailor makes the man.”*

*Proverb*

**II Discussion Points**

- 1 *As a class, discuss the proverb at the start of the lesson.*
- 2 *Debate if a dress code should be required in schools.*
- 3 *In pairs, ask your classmate to describe in English what s/he is wearing. Be sure to include colour, name of the clothing and the style.*

**III Vocabulary**

- 1 *Read and pronounce the words and phrases. Use a dictionary to find their meaning.*

|                   |                            |                                      |                    |
|-------------------|----------------------------|--------------------------------------|--------------------|
| <b>Nouns</b>      | tunic<br>sweater           | blazer<br>sweat shirt                | tank top<br>outfit |
| <b>Verbs</b>      | to dress<br>to accessorize | to change one’s clothes<br>to put on | to wear            |
| <b>Adjectives</b> | slim<br>tight              | loose<br>buttoned                    | hooded<br>baggy    |
|                   | to wear – wore – worn      |                                      |                    |

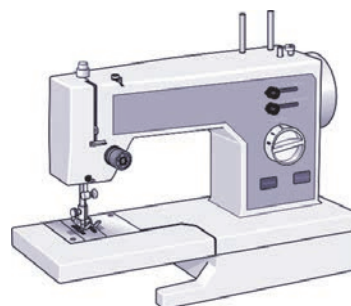

*sewing machine*

- 2 *Fill in the blanks, using the new vocabulary.*

Sally and Tom were getting ready for their first day back at school. Sally ... a dark blue skirt with a white blouse and a great looking ... over it. Tom wanted to be different. He wore ... jeans and a ... because it was hot outside. Their mother wasn’t happy about what Tom had ... and she made him ... his clothes. He came back downstairs with a nice ... shirt and some trousers that made him look dressed up. Mother told Sally that she could ... with a nice necklace and some earrings. Sally ... the earrings ... and looked at herself in the mirror.

**IV Reading**

- 1 *Read and entitle the text.*

Pupils generally want to dress nicely and change outfits as much as possible during the week. They also prefer to have clothes that are new and up-to-date. As a rule, most pupils prefer to wear ready-made clothes, or clothes that they buy from a store. Nowadays, it is not a problem to find the right garment when there are

plenty of shops with splendid clothes for pupils of all sizes and shapes.

Choosing the right clothing can sometimes be difficult, especially for teens. The main thing is to look for something comfortable and stylish. Every week, stores come out with many new clothes and



accessories. Also, every season, clothing designers present the latest fashion for teens all over the world. What is it that makes fashion so important to teenagers? Well, the young enjoy wearing nice clothes and looking good as much as their parents do. For this, for example, tunics, sweaters, shorts, jeans, pants, skirts, well-fitted buttoned shirts with stylish blazers that come in lots of different styles are often offered.

Today's teens have a greater choice of clothes than ever. Hooded sweat-shirts, tight or loose jeans and skateboard shorts are also some of the styles for modern teens.

Elegant and beautifully tailored garments for all seasons are in great demand these days. Young people in particular, love to experiment and play with fashion to express their personalities and their viewpoints.



**2 Match the picture with the correct word.**



- a) tunic;    b) baggy jeans;    c) blazers;    d) hooded sweatshirt;    e) skateboard shorts;    f) sweater

**3 Find synonyms for the following words from the text.**

- a) outfit            b) correct-sized            c) correct            d) to search            e) try            f) perspectives  
g) adolescents    h) fashionable            i) be fond of            j) superb            k) to show

**4 Answer the questions about the text.**

1. What is most important about clothes for teenagers?
2. Why is it easy to find the right garment?
3. What do teenagers want to express from their fashion?
4. What do the young enjoy?
5. What are some examples of the fashion worn by teens nowadays?

**V Listening**

**1 Listen to the text Mr. Rochester's Visitors and answer the questions:**

1. Where and when did the events happen?
2. When were the guests expected to arrive?
3. What were Mrs. Fairfax's duties?
4. How many people were there in the hall?
5. What are Amy and Louisa compared with?
6. Which person was a large, stout woman?
7. Who were the tallest people in the group?

**2** *Work in pairs to put the sentences from the text in the proper order.*

1. Blanche and Mary were of equal stature.
2. Mrs. Colonel Dent was less showy.
3. Lady Ingram was between 40 and 50.
4. There were only eight people.
5. It was a mild, quiet spring day.
6. Thursday afternoon arrived.

**VI** **Grammar**

**Remember:**

**Noun Compounds**

A noun compound is formed of two or more words. It functions as a single part of speech.

**Examples:** *fur coat, raincoat, nightdress, kid-gloves, handkerchief, handbag, sweat-pants, sunglasses, summertime, looking-glass, hairbrush, dress code, hair-dryer, hair-pin, hair-style, bathrobe.*

**1** *Insert the right word:*

*dressing-table, bedroom, nightdress, silk dress, looking-glass, handbag, fur coat, hair brush*

1. In the North, people wear ... in winter.
2. The ... in my parents ... has four drawers and a big mirror.
3. She put on her ... before going to bed.
4. My mum always has a ... and a ... in her ...
5. My cousin looked great in her new ...

**2** *Find other compound nouns in the text.*

**Remember:**

**Noun Substitutes**

- **One** and **ones** are used in place of countable nouns.

**Examples:** *I don't like this blue handbag. I like the pink one.*  
*I have bought new sunglasses, the most fashionable ones.*

- We don't use **one** in place of an uncountable noun. In this case we repeat the noun or use no noun at all.

**Examples:** *Don't use that butter. Use this fresh butter.*  
*Don't add that milk. Add this fresh.*

**3** *Pair work. Imagine you are in a ready-made clothes department. Hold a conversation using noun substitutes.*

**VII** **Writing**

- 1** *Write a paragraph of 50 words to describe what one of your colleagues is wearing.*
- 2** *Answer question 2 from Discussion Points in writing. Give three reasons why students should or should not wear a uniform to school.*

**I Pronunciation**

*Read as quickly as you can without making mistakes.*

The shoe maker's shop is shut today,  
 Oh, what shall I do with my shoes?  
 The shoe maker's shop is shut I say,  
 And there are holes in my shoes.  
 The holes in my shoes may stop my play,  
 Oh, what shall I do with my shoes?



*"Don't throw away your old shoes till you have new ones."*

*Proverb*

**II Discussion Points**

- 1 **Why do we wear shoes?**
- 2 **Why are some shoes formal and some informal?**
- 3 **Do our shoes tell others about us? Explain.**
- 4 **How important are clean, shiny shoes to you? Why?**

**III Vocabulary**

- 1 **Read and pronounce the words and phrases. Use a dictionary to find their meaning.**

|                          |                           |                          |                 |
|--------------------------|---------------------------|--------------------------|-----------------|
| <b>Nouns</b>             | walking shoes<br>gymshoes | leather shoes<br>rubbers | fur lined boots |
| <b>Verbs and Phrases</b> | to fit                    | to be in fashion         | to be too tight |
| <b>Adjectives</b>        | stylish                   | casual                   |                 |



patent leather high heeled shoes



low heeled shoes



trainers (Br. E.) / sneakers (Am. E.)



Wellington boots (Br. E.) / rubber boots (Am. E.)



high boots

- 2 **Explain what the following words mean:**

|           |        |                |
|-----------|--------|----------------|
| sandals   | model  | to present     |
| style     | season | to participate |
| to prefer | start  | to visit       |
| success   |        | to consider    |
| event     |        | to arrange     |

- 3 **Match the words with their definitions:**

- |                    |  |
|--------------------|--|
| 1. fur lined boots | a) things that one usually wears at home or on vacation        |
| 2. patent leather  | b) waterproof boots made of rubber                             |
| 3. leather         | c) the raised part of the shoe underneath the back of the foot |
| 4. trainers        | d) to be of the right size or shape; to be suitable            |
| 5. tight           | e) fixed so closely to one's feet that one can't easily move.  |
| 6. to fit          | f) special shoes for running                                   |
| 7. rubbers         | g) shoes, boots, sandals                                       |
| 8. heel            | h) things that are made to be sold                             |

- |   |  |
|---|--|
| <p>9. casual<br/>10. footwear<br/>11. goods</p> | <p>i) treated animal skin used for making shoes, bags, and clothes<br/>j) leather with a special shiny surface<br/>k) boots with inner part covered with fur</p> |
|---|--|

## IV Listening

### 1 Listen to the dialogue and fill in the blanks.

Mrs. Ciobanu: Good ... !

Shop Assistant: Hello. How ... I help you?

Mrs. Ciobanu: I ... to get a new pair of shoes.

Shop Assistant: Certainly. What kind of shoes ... you prefer, madam?

Mrs. Ciobanu: I'm looking for a pair of low-heeled ... shoes for work. I have rather small feet.

Shop Assistant: I see. Here is a pair that ... be your size. Try them on.

Mrs. Ciobanu: These are a little tight. ... you show me another pair, a size bigger?

Shop Assistant: Here you are. ... these do?

Mrs. Ciobanu: This pair is much better. I'll take them. How much are they?

Shop Assistant: Come this way, and I'll get that information for you.

### 2 Make your own dialogues about buying shoes. In pairs, perform your dialogues for the class. Listen for the words your colleagues use in their dialogues. What do you notice?

## V Reading

### 1 Read the text *At the Footwear Exhibition* and list in your copybooks the different kinds of shoes that are discussed.

The first international footwear exhibition started on the right foot the other day. This exciting event in Chisinau was fun, stylish and very interesting. Besides our country's participation, several European countries were also present, bringing their own fashion footwear. The exhibition presented a very large assortment of boots, slippers, socks, and beautiful shoes; everything for well-dressed feet.

A big number of both casual and formal footwear was on display. For example, Italy offered its latest fashion models such as high-heeled shoes, low and high-heeled boots for women, and fur lined boots for men. Romania had a big showing with a fun display of summer footwear from expensive leather sandals to light beach shoes.

Moldova also had a successful presentation of children's footwear made by local manufacturers Zorile and Tighina. The warm slippers in the shape

of fairy-tale animals attracted the visitors' attention in particular.

The event was well attended, and many who came said that they enjoyed seeing the latest styles, and appreciated the products from different parts of Europe. You'll want to make sure to be there next year to see what the new styles will be.



**2 Find synonyms in the text for the following words:**

- a) sensational      b) fancy      c) house shoes      d) guests      e) selection  
 f) the most recent      g) tall      h) attractive      i) informal      j) display

**3 Answer the questions.**

1. What happened in Chisinau recently?
2. What countries took part in the exhibition?
3. What footwear did they exhibit?
4. What did Moldova display?
5. Who visited the exhibition?
6. What kinds of products did Italy offer?

**4 Work in pairs. Find in the text antonyms for the following words:**

- |            |          |              |
|------------|----------|--------------|
| last –     | cold –   | left –       |
| cheap –    | first –  | failure –    |
| nothing –  | small –  | to dislike – |
| national – | winter – | high –       |
| boring –   | heavy –  | similar –    |

**VI Grammar**

**Remember:**

**REPORTED SPEECH - SIMPLE TENSES**

**COMPARE**

|   |   |
|---|---|
| <p>1. Radu <b>says</b>, "Mum seldom <b>visits</b> exhibitions."<br/>         1. Radu <b>says</b> his mum seldom <b>visits</b> exhibitions.</p>  | <p>1. Radu <b>said</b>, "Mum seldom <b>visits</b> exhibitions."<br/>         1. Radu <b>said</b> his mum seldom <b>visited</b> exhibitions.</p>   |
| <p>2. Peter <b>says</b>, "An exciting event <b>took</b> place in Chişinău last week."<br/>         2. Peter <b>says</b> (that) an exciting event <b>took</b> place in Chişinău last week.</p>                       | <p>2. Peter <b>said</b>, "An exciting event <b>took</b> place in Chişinău last week."<br/>         2. Peter <b>said</b> (that) an exciting event <b>had taken</b> place in Chişinău the previous week.</p>              |
| <p>3. Nick <b>says</b>, "My father <b>will buy</b> me a new pair of fur-lined boots in a week."<br/>         3. Nick <b>says</b> (that) his father <b>will buy</b> him a new pair of fur-lined boots in a week.</p> | <p>3. Nick <b>said</b>, "My father <b>will buy</b> me a new pair of fur-lined boots in a week."<br/>         3. Nick <b>said</b> (that) his father <b>would buy</b> him a new pair of fur-lined boots a week later.</p> |

**Mind the word order changes in reported questions:**

|  |  |
|--|--|
| <p>4. Dan <b>says</b>, "Where did you <b>buy</b> your shoes?"<br/>         4. Dan <b>asks</b> me where I <b>bought</b> my shoes.</p> | <p>4. Dan <b>said</b>, "Where did you <b>buy</b> your shoes?"<br/>         4. Dan <b>asked</b> me where I <b>had bought</b> my shoes.<br/> <small>wanted to know</small><br/> <small>wondered / was interested</small></p> |
|--|--|

**Remember the following changes when transforming direct speech into indirect with author's words in the Past.**

|                      |        |                                 |
|----------------------|--------|---------------------------------|
| this                 | —————> | that                            |
| these                | —————> | those                           |
| here                 | —————> | there                           |
| now                  | —————> | then                            |
| ago/back             | —————> | before                          |
| yesterday            | —————> | the day before                  |
| today                | —————> | that day                        |
| tomorrow             | —————> | the next day                    |
| next day             | —————> | the next day; the following day |
| in 3 days            | —————> | 3 days later                    |
| last                 | —————> | the previous                    |
| Present Simple       | —————> | Past Simple                     |
| Past Simple          | —————> | Past Perfect                    |
| shall                | —————> | should                          |
| will > Future Simple | —————> | would > Future-in-the-Past      |

**1 Transform the direct speech into indirect:**

- Nick said, "Unfortunately, I didn't try the shoes on before buying them."
- Pete said to Nick, "What did you do at the shoemaker's two days ago?"
- Ann said, "I don't like these sandals."
- Dan said, "I will not put on my old gymshoes."
- Nadia said, "I wore high-heeled shoes at the party."
- Mum said, "Will you go shopping tomorrow?"
- Jim said, "I'll repair my boots tomorrow."
- Tom said, "My father will visit the footwear exhibition in two days."
- Maria said to her friend, "I usually wear low-heeled shoes."
- Radu said to the shop assistant, "These shoes are not comfortable, they are too tight."
- Lucy said, "These leather shoes are in fashion now."
- Nelly said, "My father doesn't buy boots every year."
- She said, "What footwear does this shop sell?"

**VII Writing**

- Choose a sentence from the text, write it down in your copybook and then write as many questions as you can to that sentence.
- Write a paragraph of 50 words to say whether high-heeled shoes are necessary in our lives. Explain why you feel that way.

**I Let's Talk**

- 1 **1** *Say what new things you have learned from the previous lessons while discussing the topic **Appearances**.*
- 2 **2** *Give synonyms for:*  
 – turned up nose;                      – fair hair;  
 – Grecian nose;                         – stout man.
- 3 **3** *Say if you like shopping. Why yes/no?*
- 4 **4** *Describe one of your visits to a clothes department.*
- 5 **5** *Explain in your own words the quotation:*  
 “No man could tell what he would do if he were in the shoes of another man”  
*(J. Galsworthy)*

**II Let's Read and Talk**

- 1 **1** *Read the extract for comprehension.*

“Mama said that Moris Gough was a typical young Englishman, so nice and with such good manners; but how we laughed – at least Bob and I did – when he came out the next day to go riding in the bush dressed in narrow pants<sup>1</sup>, long polished boots, a silk shirt and a

big hat. We gave him a bad time, I'm afraid. He lost his hat and got his shirt all dirty the first day he went out with us: had a bad fall when his horse suddenly stopped before a pit<sup>2</sup> full of water. Moris fell right into it.”

*(After Katharine Susannah Prichard)*

<sup>1</sup> pants [pænts] n. – pantaloni

<sup>2</sup> pit [pɪt] n. – groapă

- 2 **2** *Describe what Moris looked like and how he was dressed.*
- 3 **3** *Speak about Moris' adventures in the bush.*
- 4 **4** *Say who laughed at Moris and why they did so.*
- 5 **5** *Retell the extract.*

**III Grammar****Revision**

- 1 **1** *Find the possessive case and determine the plurals and singulars of the nouns below.*

|   |  |
|---|--|
| <ol style="list-style-type: none"> <li>a) Where are my brother's glasses?</li> <li>b) Have you heard the news? It's very interesting.</li> <li>c) That information was very useful.</li> <li>d) Everybody spoke about my friend's progress in English.</li> <li>e) Sandu wants to know who the author of this book is.</li> </ol> | <ol style="list-style-type: none"> <li>f) Parents always give good advice to their children.</li> <li>g) Tomorrow Radu will buy himself a new pair of spectacles.</li> <li>h) Angela's clothes are always tidy.</li> <li>i) – Where's your money?<br/>– It's in my pocket/purse.</li> <li>j) What's the colour of your mother's hair?</li> </ol> |
|---|--|

**2 a) Point to the noun compound and one/ones as a noun substitute.**

1. – Which of the raincoats in the picture do you like best?  
– The blue one.
2. The jeans I like most are the ones my mother bought in Italy.

**Say which nouns from the sentences were substituted by one/ones.**

**b) Make up similar examples.**

**3 Fill in the blanks with the prepositions with, from, to, of, for, at, on.**

- a) His face is familiar ... me.
- b) Marcel bought a tube of tooth-paste ... 10 lei.
- c) I'm not familiar ... the hygiene rules.
- d) There's no remedy ... some diseases.
- e) Never laugh ... ugly people.
- f) They soon recovered ... sickness.
- g) John got angry ... his father who refused to buy him new sneakers.
- h) It depends much ... the correct doctor's decisions when treating an infectious disease.
- i) I compared Monica's appearance ... her mother's.

**4 Open the brackets using the verb in the proper tense and voice:**

- a) You (to visit) this footwear shop before? We usually (to buy) slippers, shoes, boots and high boots here.
- b) My friend Stela told me (that) she (to clean) her teeth in the morning.
- c) The personal hygiene things like combs, tooth-paste and soap (to sell) at a low price.
- d) When Bill rang me up I (to wash) my hair in the bathroom.
- e) Different stylish sandals (to exhibit) at our shop now.

**5 Think of suitable adjectives to insert in the sentences below:**

- a) I admire people who are ... and ... .
- b) I don't like people who are ... and ... .
- c) I think people who are ... and ... are often ... .
- d) I would like to be ... and ... .
- e) I am certainly not ... or ... .

**6 Rewrite the sentences using reported speech.**

- a) He said, "I hurt my arm yesterday."
- b) Mum asked, "How did you twist your ankle?"
- c) She said, "Does Amy dye her hair?"
- d) Pete said, "My arms are so long that I can't find shirts to fit me."
- e) He said, "Ann broke her wrist in an accident."
- f) The boy says to his father, "When shall we go to the footwear exhibition?"
- g) Lily said, "I am sorry, I will not join you at the party."
- h) She said, "The dress I bought yesterday is too loose."
- i) Linda said, "What did you like at the fashion show last week?"
- j) Greg said, "Why didn't you come to the meeting on Sunday?"



**I Pronunciation**

*Read as quickly as you can:*

A mother and father called Leather  
 Had children as light as a feather.  
 When the weather was rough [rʌf]  
 They weren't heavy enough,  
 So they had to be tethered<sup>1</sup> together.

<sup>1</sup> to tether ['teðə] v. – a priponi, a lega



*“The family is one of nature’s masterpieces.”*

*George Santayana*

**II Conversational Formulas**

*Which of the phrases below will you use in certain situations when asking permission:*



- Could I ...?
- I'd like to ... if that's all right.
- Do you mind if ...?
- May I (please) ...?
- Is it all right if I ...?



- Would it be possible ...?
- Is there any objection ...?
- Any chance of ...?
- With your permission, can I ...?

**III Discussion Points**

**1** Explain the proverb *“Like mother like daughter (Like father like son).”*

**2** Debate on the questions below:

- a) Do mothers or fathers have more influence upon children?
- b) Are mothers or fathers more worried about daughters?

**3** Imagine your parents are far away. Say how you will face difficulties.

**4** Comment on the quotation of the lesson. Say how you understand it.

**IV Vocabulary**

**1** Read and pronounce the words and phrases. Use a dictionary to find their meaning.

|                               |  |   |
|-------------------------------|--|---|
| <b>Nouns</b>                  | mother/daughter/sister-in-law<br>step-mother/brother<br>close relations/relatives<br>distant relatives/relations | blood relatives<br>widow / widower<br>twins<br>spouse         |
| <b>Verbs and Verb Phrases</b> | to grieve<br>to treat  | to watch over/to care for<br>to be neighbourly/to be friendly |

**2** In pairs, match the words with their definitions:

- |                  |                                      |
|------------------|--------------------------------------|
| 1. spouse        | a) two children born at one birth    |
| 2. widow         | b) a mother of one's husband or wife |
| 3. widower       | c) to feel very sad about something  |
| 4. twins         | d) a man whose wife has died         |
| 5. mother-in-law | e) to feel affection for somebody    |

- |                   |                                   |
|-------------------|-----------------------------------|
| 6. to grieve      | f) a husband or a wife            |
| 7. close relative | g) a woman whose husband has died |
| 8. to care for    | h) a person connected by blood    |

### 3 Fill in the blanks:

The son of my brother is my ... .  
 My brother's mother is my ... .  
 Your grandfather's son is your ... .  
 Your father's new wife is your ... .  
 Her aunt's children are her ... .

The daughter of my sister is my ... .  
 My mother's sister-in-law is my father's ... .  
 My cousin's mother is my ... .  
 His mother's second husband is his ... .  
 Your sister's husband is your ... .

## V Reading

### 1 Read and say what you think of the family in the text.

#### MARGARET'S LETTER

My dearest mother! We can't tell you how happy your last letter made us feel. We were so happy to hear that Aunt Sally is feeling so much better, and that she will be back to helping Granddad as she used to do.

All my sisters are as good as gold. Jo helps me with the sewing, and insists on doing all sorts of hard jobs around the house. Beth is as regular about her tasks as a clock, and never forgets what you told her about being good. She is sad that you and father are both away, and is very serious when she plays the piano. Amy minds nicely, and I take good care of her. She does her own hair, and I am teaching her to accessorize her clothes. She tries very hard and I think you will be pleased with her improvement when you come home. Our cousin Laurie watches over us like a motherly old hen, and is very kind to us.

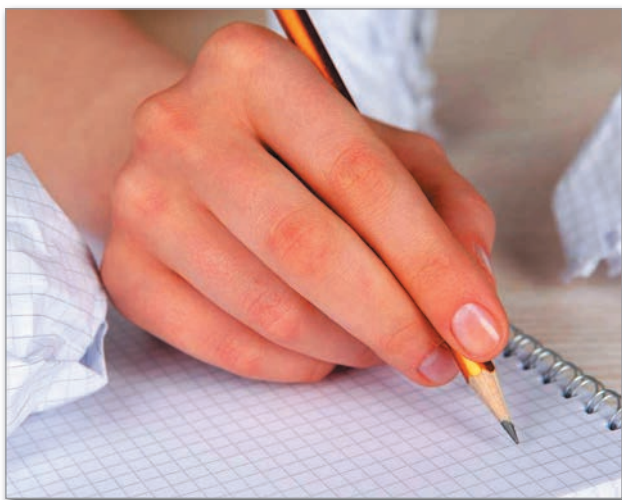

He and Jo keep us laughing, for we get sad sometimes with you so far away.

We are all well and busy. But we miss you and want you to come home as soon as possible. Please, give my love to father.

*Ever your own, Meg.*

*("Little Women" by L. M. Alcott)*

### 2 Find in the text antonyms for the following words:

|         |               |        |         |
|---------|---------------|--------|---------|
| first - | rude -        | glad - | young - |
| bad -   | to remember - | cry -  | free -  |

### 3 Say what is meant by the following:

- ... as good as gold;
- ... is as regular about her tasks as a clock;
- ... watches over us like a motherly old hen;

### 4 Answer the questions:

- a) Why are the sisters alone?
- b) What does Jo do to help Margaret?
- c) What can you say about Beth and Amy?
- d) Who keeps the girls merry?
- e) Why do the girls feel like orphans?

### 5 Read the text again and summarize it.

**VI Grammar****REMEMBER**

Use Present Simple after conjunctions: **if, as soon as, when, till, until, after, before, in case, in clauses of time and condition referring to the future.**

**E. g.:** If I come on time, mum won't scold me. As soon as father buys a new car, we'll all go on a trip.

**1 Open the brackets:**

- When I (to finish) school, I'll go to my grandparents in the countryside.
- Uncle Tudor will not visit his relatives in Romania until he (to gather) the crops.
- Your elder brother Costel will certainly help you if you (to ask) him.
- After you (to study) your family tree, you (to find out) where you descend from.
- In case a child (to become) an orphan, a family (to adopt) him or her.
- I hope my cousin (to reach) the station before the train (to arrive).

**2 Make up sentences with as soon as, if, when, till, until, after, before, in case using:**

godmother  
godparents

step-parents  
fore parents

parents-in-law  
brother (sister) – in-law

**VII Writing****1 Do exercise 2 (VI) in writing.****2 Draw and label your own family tree.****3 Write a summary of the text in 50 words.****VIII Listening****1 Listen to the story and answer the questions below:**

- What is the mystery?
- Who thinks he solved the mystery?
- What is a "ginger"?
- What does "black Irish" mean?
- Who had hair like Tim and Tom?

**2 Say whether the following sentences are true (T) or false (F).**

- Tim and Tom's family are all redheads.
- Tim and Tom have their father's eyes.
- The family jokes that Tim and Tom were kissed by a leprechaun.
- Tim and Tom have their mother's dimples.
- Aunt Lizzie found an old photo.
- The family knows for sure that Aunt Lizzie was a ginger.

**3 Listen to the text again and answer the questions.**

- How many colours do you hear named? What are they?
- What adjectives to describe hair do you hear?
- What words to describe family do you hear? List them.
- Does Tim have any brothers? Explain your answer.
- What is a sign of beauty in Ireland?



**I Pronunciation**

**Read as quickly as you can:**

Smile a while, and while you smile,  
others'll smile, and then there'll be miles of smiles.

*"Many countries,  
many customs."  
(Proverb)*



**II Conversational Formulas**

**Use the phrases below in microdialogues when congratulating:**



- My warmest congratulations.
- Let me congratulate you on ...
- I'd like to congratulate you.
- Congratulations!



- Happy birthday!
- Happy anniversary!
- Have a happy anniversary!
- Merry Christmas and a Happy New Year!

**III Discussion Points**

- 1 Brainstorm words related to the lesson topic.**
- 2 As a class, discuss the following:**
  - a) the typical traditions observed in Moldova.
  - b) how traditions in Moldova are similar or different to those in Great Britain.
- 3 Say how you understand the lesson proverb.**

**IV Vocabulary**

**1 Read and pronounce the words and phrases. Use a dictionary to find their meaning.**

|                               |   |  |   |                        |
|-------------------------------|---|--|---|------------------------|
| <b>Nouns and Noun Phrases</b> | engagement<br>fiancé/fiancée<br>wedding | bride<br>bride-groom<br>god parent(s)/son              | bridesmaid<br>the best man<br>wedding reception | honey moon<br>marriage |
| <b>Adjectives</b>             | festive                                 | merry  | enjoyable                                       |                        |
| <b>Verbs and Phrases</b>      | to bless<br>to pray to God              | to keep (up the) tradition<br>to baptize / to christen | to celebrate/to mark                            |                        |

**2 Work as a class. Fill in the gaps with a suitable word from the new vocabulary.**

- a) Anne and Mihai's ... was announced to everybody.
- b) Diana's ... to Radu was welcomed by her family.
- c) There were some famous people at their ... .
- d) The ... was dressed in white while the ... in black and white.
- e) After the wedding reception, the newly married couple spent their ... at the seaside.

**3 Work in pairs. Match the words with their definitions:**

- |   |   |
|---|---|
| <ol style="list-style-type: none"> <li>1. ceremony</li> <li>2. enjoyable</li> <li>3. bridesmaid</li> <li>4. distraction/entertainment</li> <li>5. fiancée</li> <li>6. to baptize</li> </ol> | <ol style="list-style-type: none"> <li>a) full of colour and happiness (about holidays)</li> <li>b) something that gives one pleasure</li> <li>c) a formal event such as a wedding</li> <li>d) the man one is engaged to</li> <li>e) a girl who helps and accompanies a bride on her wedding day</li> <li>f) a woman engaged to be married</li> </ol> |
|---|---|

7. festive  
8. fiancé

- g) activity that is intended to entertain people  
h) to immerse (a cufunda) somebody in water as a sign that he or she has become a member of a Christian church

## V Reading

- 1 Read the text and say what you liked most in it.

### GOLDEN JUBILEE

Recently, the Croitorus have marked their 50<sup>th</sup> wedding anniversary. That means they founded their family 50 years ago. And now, looking at their joyful faces, one can observe, with confidence, that they've led a life of harmony, happiness and pleasure.

Regarding the jubilee itself, it is quite necessary to make clear how it came into being. To begin with, the Croitorus' sons – Andrew, Peter and Greg, together with their wives, children and grandchildren had a special meeting some days before the anniversary. At that meeting they planned how to celebrate their parents' Golden Jubilee. It was also agreed to keep the idea a big secret so that the celebration could be a surprise for the old couple. To implement the plan, the three brothers' families did all the necessary things. First, they bought the wedding clothes, then prepared



food for the reception table, and, finally, invited their closest relatives and friends.

Now imagine what the ceremony looked like. The Croitorus were dressed in solemn wedding clothes, the hall was decorated with flowers, the noisy guests were seated at the table which was laid with tasty things. Of course, wishes were made to the Heroes of the Day on whose faces one could easily see gratefulness, happiness, enjoyment and satisfaction. Yes, that is how it really was; a wonderful surprise.

- 2 Group the underlined words from the text into three columns: nouns, verbs and adjectives; give their synonyms.

- 3 Find in the text the words denoting:

- |                         |                                     |                               |
|-------------------------|-------------------------------------|-------------------------------|
| – parents and children; | – the 50 <sup>th</sup> anniversary; | – two people who are married; |
| – a marriage ceremony;  | – members of one's family;          | – a pleasure one feels;       |
|                         |                                     | – something unexpected.       |

- 4 Ask and answer questions about the text.

- 5 Work as a class. Say:

- a) how long your parents, grandparents have been living together;  
b) if it is customary to celebrate parents' and grandparents' wedding anniversaries in your family. If yes, say which one you celebrated last;

## VI Listening

- 1 Listen to the text and:

- |  |  |
|--|--|
| a) write down the characters' names;             | e) name the three amazing moments in the story;                |
| b) say where the action takes place;             | f) say who Clark was and why he shouted "They're coming boys!" |
| c) speak about the reason the people were there; |  |
| d) give the names of the Heroes of the Day;      |  |

- 2 **Brainstorm a list of titles for the text and choose the best one.**

**VII Grammar**

**Remember:**

**REPORTED SPEECH - PROGRESSIVE TENSES**

| <i>Direct Speech</i>  | <b>COMPARE</b> | <i>Indirect Speech</i>  |
|---|----------------|---|
| 1. She said, "I <b>am writing</b> an invitation <b>now</b> ."   |                | 1. She said (that) she <b>was writing</b> an invitation <b>then</b> .                                 |
| 2. Marry said, "What <b>are you celebrating</b> , Ann?"   |                | 2. Marry asked Ann what she <b>was celebrating</b> .  |
| 3. Bianca said, " <b>Look</b> , Ann! The bride <b>is not wearing</b> a white dress, she is wearing a pink one." |                | 3. Bianca remarked (that) the bride <b>was not wearing</b> a white dress, she was wearing a pink one. |
| 1. Olga said, "I <b>was receiving</b> guests <b>when</b> you called me <b>yesterday</b> ."                      |                | 1. Olga said (that) she <b>was receiving</b> guests <b>when</b> I called her <b>the day before</b> .  |
| 1. Betty said, "We <b>will be decorating</b> the house tomorrow <b>from 2 p.m. till 4 p.m.</b> "                |                | 1. Betty said they <b>would be decorating</b> the house <b>from 2 p.m. till 4 p.m.</b>                |

| <b>Remember the following changes:</b> |  |
|--|--|
| Present Progressive                    | —————> Past Progressive                                    |
| Past Progressive                       | —————> Past Perfect Progressive (usually Past Progressive) |
| Future Progressive                     | —————> Future Progressive-in-the-Past                      |

- 1 **Report the following:**

1. Pete said, "I am writing congratulation cards now."
2. Jane said, "Oh, are you buying Christmas presents, Ann?"
3. He said, "Dan, what were you celebrating when I called you yesterday evening?"
4. Mum said, "The priest will be christening my daughter at 10 a.m. tomorrow."
5. The bridesmaid said, "I will not be wearing a dark dress at my friend's wedding."

- 2 **Think of 5-6 sentences your friend told you and report them. Use Present, Past and Future Progressive. Work in pairs.**

**VIII Writing**

- 1 **Do exercise 2 (VI) in writing.**
- 2 **Your cousin is going to marry. As you can't be present, write him or her a congratulation card.**
- 3 **Write a description of a party you have been to.**

**I Pronunciation**

*Read as quickly as you can:*

Betty Botter bought some butter,  
 But she said, "This butter's bitter.  
 If I put it in my batter,  
 It will make my batter bitter.  
 But a bit of better butter,  
 That would make my batter better."



*"Recipes don't work unless you use your heart!"*

*Dylan Jones*

**II Conversational Formulas**

*In pairs, practice microdialogues when offering and accepting food or drink.*



- Would you like...?
- Would you care for some...?
- Can I offer you any...?
- I hope you're hungry.
- Please, enjoy some...
- Will you join me in having some...?



- Thank you, that would be nice.
- No, thank you.
- That sounds great.
- I could eat something.
- I would love some.
- I will have a piece, thank you.

**III Discussion Points**

*Answer the questions with your classmates.*

1. What foods do you like to eat?
2. What foods have you prepared yourself?
3. What is needed to make your favourite foods?
4. What does the lesson quote mean to you?

**IV Vocabulary**

- 1** *Read and pronounce the words and phrases. Use a dictionary to find their meaning.*

|       |                         |             |
|-------|-------------------------|-------------|
| Nouns | oven                    | baking soda |
|       | dough                   | walnut      |
|       | chocolate chips         | extract     |
|       | all-purpose wheat flour |             |

|                        |                         |                |
|------------------------|-------------------------|----------------|
| Verbs and Verb Phrases | to mix                  | to preheat     |
|                        | to bake                 | to refrigerate |
|                        | to place                | to stir        |
|                        | to beat                 | to cool        |
|                        | to beat - beat - beaten |                |

- 2** *Work in pairs to match the words with their definitions.*

- |                |   |
|----------------|---|
| 1. dough       | a) an enclosed space for baking           |
| 2. to bake     | b) to set or lay something                |
| 3. flour       | c) active ingredient taken from something |
| 4. baking soda | d) a kind of nut with an outer shell      |
| 5. to beat     | e) to cook something in an oven           |
| 6. to preheat  | f) powder from ground grain               |
| 7. walnut      | g) to mix ingredients                     |
| 8. oven        | h) mixture of flour and water or milk     |
| 9. to stir     | i) powder to make baked goods rise        |
| 10. to place   | j) to stir with energy to make smooth     |
| 11. extract    | k) to warm the oven to bake something     |

**V Reading**

- 1 Read the recipe and find the words you don't know, then use a dictionary and fill in the lines with the correct verbs: *bake, cool, stir, combine (2), add, preheat, refrigerate, place, beat*

**CHOCOLATE CHIP COOKIES – AN AMERICAN FAVOURITE****Ingredients:**

1 cup (226g) unsalted butter at room temperature  
 3/4 cup (150g) white sugar  
 3/4 cup (160g) packed brown sugar  
 2 large eggs  
 1 1/2 teaspoons pure vanilla extract  
 2 3/4 cups (315g) all-purpose wheat flour<sup>1</sup>  
 1 teaspoon baking soda  
 1/2 teaspoon salt  
 1 1/2 cups (semi-sweet) chocolate chips  
 1 cup (100g) of coarse<sup>2</sup>-cut walnuts



<sup>1</sup> all-purpose wheat flour (n.) – făină integrală

<sup>2</sup> coarse [kɔ:s] adj. – mășcat

- \_\_\_ the oven to 190 C. Line two baking sheets with wax paper and set aside.
- In a bowl, cream the butter. \_\_\_ the white and brown sugar and \_\_\_ until fluffy (about 2 min.). \_\_\_ eggs one at a time and stir in well. Add vanilla and \_\_\_ mixture very well.
- In a separate bowl \_\_\_ the flour, baking soda, and salt. Add the dry ingredients to the egg mixture. Mix well adding the chocolate chips halfway. If the dough is too soft, cover and \_\_\_ until firm (about 30 min.).
- With a table spoon, make a small ball of dough (4cm diameter) and \_\_\_ it on the prepared cookie sheets. \_\_\_ for 12-14 min. or until golden brown. \_\_\_ completely before eating.

**2 Answer the questions about the recipe.**

1. At what temperature do the cookies need to be baked? For how long?
2. If we doubled the sugar, how many cups would we need?
3. What do we do if the cookie dough is too soft?
4. What do 'fluffy' and 'semi-sweet' mean?
5. In what shape should we make the dough?

**VI Listening****1 Listen to the dialogue 'At the Bucuria Confectionery' and answer the questions.**

1. Why is the customer buying at Bucuria?
2. What kind of products are sold at Bucuria?
3. How many boxes of Moldova chocolates does the customer buy?
4. Why does the customer need to buy so much?
5. How much does the chocolate cake cost?



**VII** Grammar**Reported Speech – Imperative Sentences**

**When reporting commands, requests and suggestions we use introductory verbs: ask, tell, order, advise, invite, etc.**

| Direct Speech  | COMPARE | Indirect Speech  |
|--|---------|--|
| 1. Mom <b>said</b> , “Wash your hands.”                        |         | 1. Mom <b>told</b> us <b>to wash</b> our hands.            |
| 2. Doru <b>said</b> , “Sally, <b>don’t let</b> the cake burn.” |         | 2. Doru <b>told</b> Sally <b>not to let</b> the cake burn. |
| 3. Ion <b>said</b> , “Let’s have a good time.”                 |         | 3. Ion <b>suggested</b> having a good time.                |

**1** Report the following:

1. Bill said, “Be sure to stir the batter well.”
2. Jane said, “Give me the recipe.”
3. Dad said, “Don’t make a mess in the kitchen.”
4. Tim told his brother, “Don’t eat all the cake.”
5. Ionela said, “Preheat the oven to 190 degrees.”
3. Tania said, “Let’s have a party!”

**VIII** Writing

- 1** Write a paragraph of at least 50 words to describe your favourite dessert.
- 2** Choose one of the baked goods from the pictures below and write its recipe.



**I Pronunciation**

*Read as quickly as you can:*

- a) A proper cup of coffee from a proper copper coffee pot.
- b) How many cookies could a good cook cook, if a good cook could cook cookies?



*“At a dinner party one should eat wisely but not too well, and talk well but not too wisely.”*

*W. Somerset Maugham*

**II Discussion Points**

- 1 *Speak on food and drinks you have at holiday parties in your families.*
- 2 *Brainstorm the table manners you know.*
- 3 *Explain the proverb “Tastes differ.”*
- 4 *Say how you understand the lesson quote.*

**III Vocabulary**

- 1 *Read and pronounce the words and phrases. Use a dictionary to find their meaning.*

|                   |  |   |                              |                                      |
|-------------------|--|---|------------------------------|--------------------------------------|
| <b>Nouns</b>      | get-together<br>tableware/dishes<br>(plates, glasses, cutlery) | dish/particular food<br>poultry<br>pork | beef<br>lamb/mutton<br>steak | cabbage rolls<br>pudding<br>beverage |
| <b>Adjectives</b> | home-made  | sour                                    | roast                        | tinned/canned                        |

- 2 *Fill in the blanks using the words: pudding, beverage, poultry, get-togethers, home-made, cabbage rolls, roast lamb, steak.*

- a) Will you, please, go to the shop and buy some ... ?
- b) Father likes neither pork nor beef. He prefers ... .
- c) Beef ... is a widely popular meat dish.
- d) The Christmas ... was set on the table.
- e) ... bread has a special taste.
- f) It takes a housewife much more time to make ... .. than a salad.
- g) ... .. is a traditional Easter food in Moldova.
- h) I enjoy our family ... .

- 3 *Work in groups. Name the ingredients cabbage rolls and cakes are made of.*

**IV Reading**

- 1 *Read the text and find the words you don't know in the dictionary.*

Dinner was almost ready when Pa and Mr. Boast came back with the bobsled. The enormous rabbit was browning in the oven. Potatoes were boiling, and the coffee pot bubbled ([bʌbl] a clocoti) on the back of the stove. The house was full of the good smells of roasting meat, hot bread, and coffee.

Laura spread the clean white tablecloth, and in the centre of the table she set the glass sugar bowl, the glass jug full of cream, and the glass spoon-holder full of silver spoons. Around the table Carrie laid the knives and forks, and filled the water glasses, while Laura set all the plates in a pile at Pa's place. Then at each place,

all around the table, she cheerfully put a glass sauce dish holding half a canned peach in golden syrup. The table was beautiful.

Before Pa, on the big platter, lay (lie-lay-lain) the huge roasted rabbit with piles of bread-and-onion stuffing ([stʌfɪŋ] *umplutură*) steaming ([sti:m] - *a aburi*) around it. From a dish on one side stood a mound

(*morman*) of mashed potatoes, and on the other side stood a bowl of rich, brown gravy. There were plates of hot corn bread and of small hot biscuits. There was a dish of cucumber pickles.

Ma poured the strong brown coffee and tea, while Pa heaped ([hi:p] - *a umple*) each plate with roast rabbit, stuffing, potatoes, and gravy.

(After L. I. Wilder)

- 2 Choose from the text the words referring to meals and tableware.
- 3 Find in the text the information about:
  - the number of people present at the dinner table;
  - what each member of the family did;
  - the tableware;
  - the food served.
- 4 Ask questions on the text.
- 5 In small groups, brainstorm a list of appropriate titles to the text. Choose the best one. Justify your choice.

## V Grammar

Remember:

### REPORTED SPEECH - PERFECT TENSES

| Direct Speech  | COMPARE | Indirect Speech  |
|--|---------|--|
| 1. Andrew said, "Mum has cooked tasty food for the holiday table". |         | 1. Andrew said (that) his mum had cooked tasty food for the holiday table. |
| 1. Tim said, "I had arrived in Moldova by the end of June".        |         | 1. Tim said (that) he had arrived in Moldova by the end of June.           |

#### Remember the following changes:

|                 |        |              |
|-----------------|--------|--------------|
| Present Perfect | —————→ | Past Perfect |
| Past Perfect    | —————→ | Past Perfect |

- 1 Report the following sentences:
  1. Ion said, "Tim, have you ever tried Moldovan pies?"
  2. My friend said, "I have never eaten mutton."
  3. Dad said, "I have bought pork, poultry and beef for the holiday table."
  4. Andrea said, "When I returned home, mum had already baked the pies."
  5. Laura said to Emily, "I am so sorry I had not managed to lay the table before the guests arrived."
  6. The boy said, "My parents have never used canned products."
- 2 Make up 6 sentences, using the grammar above.

## VI Writing

- 1 Do ex. 1 (V) in writing.
- 2 Write at least 10 table manners you should observe.
- 3 Describe in writing your last family holiday table.

**I Pronunciation**

**Read as quickly as you can:**

It takes two to tango  
 To tango takes two.  
 But when do they tango  
 And who tango who?

*“Your friend is the person who knows all about you, and still likes you!”*

*Elbert Hubbard*



**II Conversational Formulas**

**In which situation will you use the phrases below when thanking and responding?**



- Thanks ...
- That is really nice of you ...
- I really can't thank you enough ...
- What a wonderful surprise ...
- This means a lot to me ...



- Don't mention it.
- It's a pleasure.
- That's all right.
- Any time.
- It was nothing.
- I am glad I could help.

**III Discussion Points**

**1 Discuss with your partner:**  
 a) **What are the advantages and disadvantages of making friends on line?**  
 b) **What other places are good for making friends?**

**2 Think and answer:**  
 a) What does a lasting friendship depend on?  
 b) Do you usually initiate friendship or wait to be approached?

**3 Say what it means:**  
 a) He speaks well of us behind our backs  
 b) He lends a hand with my homework.

**4 Explain the proverbs:**  
 a) Better an open enemy than a false friend.  
 b) A friend to all is a friend to none.

**5 Comment on the quotation of the lesson.**

**IV Vocabulary**

**1 Read and pronounce the words and phrases. Use a dictionary to find their meaning.**

|                               |                          |                         |   |
|-------------------------------|--------------------------|-------------------------|---|
| <b>Nouns and Noun Phrases</b> | liar<br>traitor          | betrayal<br>true friend | lasting friendship                      |
| <b>Verbs and Verb Phrases</b> | to befriend<br>to betray | to share<br>to argue    | to lend a hand<br>to rely on / to trust |
| <b>Adjectives</b>             | mean<br>reliable         | sincere<br>selfish      | candid                                  |
|                               |                          | to lend – lent – lent   |   |

**2 Match the words with their definitions:**

- |                        |   |
|------------------------|---|
| 1. to trust/to rely on | a) unkind, evil, cruel                                |
| 2. to argue            | b) somebody who thinks only of himself; greedy        |
| 3. liar                | c) open, honest and sincere in manner                 |
| 4. mean                | d) to believe somebody is honest and will not do harm |
| 5. selfish             | e) to express disagreement in words, to quarrel       |
| 6. candid              | f) a person who tells lies                            |
| 7. to befriend         | g) to make friends with someone                       |

**3 Work as a class. Fill in the gaps with a suitable word from the box.**

- Their ... has lasted since they were classmates.
- A good and ... .. is one who likes and never ... you.
- Costel is a real friend to all of us and you can always ... .. him.
- Respect and honour are so important for a ... ..
- Are you always ready to ... everything with your friend?
- A ... .. is ready to lend everything, give everything that will help you through.

share  
close friend  
true friend  
rely on  
betrays  
lasting friendship  
relationship

**V Reading**

**1 Read the text. As a class, discuss the meaning of the new words and phrases which appear in the text.**

**HOW TO BEFRIEND?**

One can't imagine living without friends.

When do people decide if they want to become friends? As Dr. Leonard Zunin thinks, the first four minutes of contact are decisive. He offers this advice to anyone who is about to start a new friendship: if you are meeting someone in a social situation, give him your full attention for four minutes.

If somebody is introducing us to new people, he or she suggests that we should try to be friendly, open and self-confident<sup>1</sup>. In general, he says, "People like people who like themselves". On the other hand, we should not make other people think we are too sure of ourselves. It is important to be interested and sympathetic, realizing the other person has his own needs, hopes, and fears.

Nevertheless, is it honest to give the appearance of friendly self-confidence when we don't actually feel that way? Perhaps, not, because according to



Dr. Zunin, "total honesty" is not always good for social relationships, especially during the first minutes of contact. There is a time for everything. Some play-acting may be very good for the first minutes of contact with a stranger. Certainly, it is not the time to complain about one's health or to find faults with other people. It is the time to tell the whole truth about one's opinions and impressions.

<sup>1</sup> self-confident [self 'kɒnfɪdənt] – sigur de sine

**2 Find in the text synonyms for the following words:**

|                         |                           |  |
|-------------------------|---------------------------|--|
| to make up one's mind – | to propose/to recommend – | to get acquainted with/to present to – |
| touch/connection –      | sure of himself –         | point of view –                        |
| understand –            | great, significant –      | wish/aspiration –                      |

**3 Answer the questions:**

- What should you give to a person when meeting him in a social situation?
- What does the author suggest doing when introducing people?
- What should one realize when making friends?
- Is it the time to complain about one's health when making friends? If not, say why.
- Is it the time to tell the whole truth about one's opinions and impressions, isn't it? Why?

**4 Summarize the text.****VI Grammar****Revision:****1 Work in pairs. Report the following:**

- Pete said, "I am writing a letter to my friend now."
- Paul said, "I have never betrayed my friend."
- Tom said, "Mum, I am not telling lies."
- Marius said, "Oliver, will you lend me a hand, please?"
- He said, "Were you arguing with Bill when I came in?"
- She said, "I had always shared my joys and sorrows with my mum before she left for Italy."
- My sister said, "Why was your friend laughing at you?"
- The boys said, "We are not quarrelling, we are discussing a new project."

**VII Writing****1 Write the corresponding characteristics in 3 columns using vocabulary on the topic Friends. Use a dictionary.**

|                                 |   |  |
|---------------------------------|---|--|
| People like friends<br>who are: | People don't want their<br>friends to be: | People aren't sure about a<br>friend who is: |
| E. g. <u>honest</u>             | <u>liars</u>                              | <u>selfish</u>                               |
| _____                           | _____                                     | _____  |

**2 Describe an ideal friend in 40-50 words. Use the new vocabulary.****VIII Additional Information***It's Interesting to Know*

... One of the most modest and yet one of the best known monuments in Edinburgh is the monument to a dog called Bobby. The dog belonged to John Gray.

When he died, Bobby lived near his grave for fourteen years. Later Bobby was buried near his master and his statue in the Old Town has become a symbol of devotion.



**I Let's Talk**

**1** Say how the members of the Royal Family are related to each other.

# The Royal Family Tree

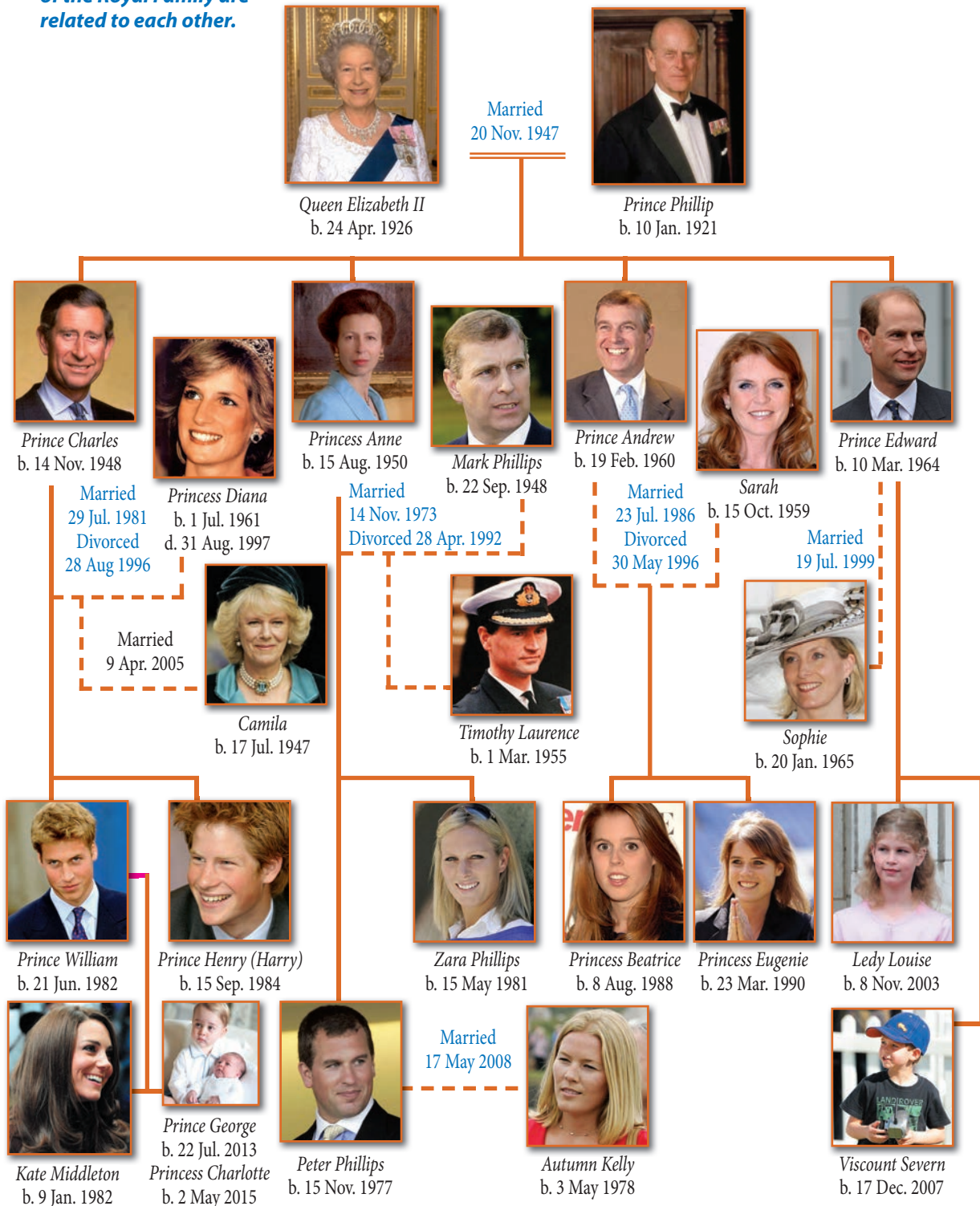





**I Pronunciation**

*Read as quickly as you can:*

The art of Biography  
Is different from Geography.  
Geography is about Maps,  
Biography is about Chaps<sup>1</sup>.

<sup>1</sup> chap [tʃæp] n. – băiat, flăcău



*“England is the paradise of individuality, eccentricity, hobbies, and humour.”*

*George Santayana*

**II Conversational Formulas**

*Use the phrases below in microdialogues:*



- Have you been ...?
- Have you visited ...?
- I strongly recommend that you ...?



- I have been there.
- That sounds wonderful.
- Thank you for the tip<sup>1</sup>.

<sup>1</sup> tip [tɪp] n. – sfat, informație

**III Discussion Points**

*As a class, answer the questions:*

1. What do you know about the UK?
2. Have you ever visited the UK? If yes, say what impressed you most. If no, say if you would like to visit it. Why?
3. What do you know about London?
4. How do you understand the lesson quote?

**IV Vocabulary**

- 1** *Read and pronounce the words and phrases. Use a dictionary to find their meaning.*

|                   |                     |  |          |
|-------------------|---------------------|--|----------|
| <b>Nouns</b>      | lowland<br>highland | The House of Commons<br>The House of Lords | monarch  |
| <b>Verbs</b>      | to surround         | to appoint                                 | to crown |
| <b>Adjectives</b> | picturesque         | navigable                                  | royal    |

- 2** *Work in pairs. Match the words with their definitions:*

- |                |   |
|----------------|---|
| 1. to appoint  | a) a King or a Queen who reigns over a country              |
| 2. to surround | b) to circle, to encircle, to ring                          |
| 3. to crown    | c) to give royal power to                                   |
| 4. picturesque | d) attractive, interesting and unspoiled place              |
| 6. royal       | e) belonging to a king, a queen or a member of their family |
| 7. monarch     | f) to choose someone for a job                              |

- 3** *Learn to read the geographical names that will be used in the text.*

The United Kingdom ..... [ju:ˈnɑɪtɪd ˈkɪŋdəm]      British Isles ..... [ˈbrɪtɪʃ ˈaɪləz]  
The English Channel..... [ˈɪŋɡlɪʃ ˈtʃænl]      Europe..... [ˈjʊərəp]

|                         |                    |                  |               |
|-------------------------|--------------------|------------------|---------------|
| Northern Ireland .....  | ['nɔːðən 'aɪələnd] | Southampton..... | [saʊθ'æmptən] |
| The Extreme North ..... | [ɪk'stri:m 'nɔːθ]  | Portsmouth.....  | ['pɔːtsməθ]   |
| The Severn .....        | ['sevən]           | Glasgow.....     | ['glɑːsgəʊ]   |
| The Thames .....        | [temz]             | Edinburgh.....   | ['edɪnbərə]   |
| Lake District.....      | ['leɪk 'dɪstrɪkt]  | Cardiff.....     | ['kɑːdɪf]     |
| Manchester .....        | ['mæntʃɪstə]       | Belfast.....     | [bel'fɑːst]   |
| Birmingham .....        | ['bɜːmɪŋgəm]       | Loch Ness.....   | ['lɒk 'nes]   |
| Bristol.....            | [brɪstl]           | The Tweed.....   | [twiːd]       |
| Liverpool.....          | ['lɪvəpuːl]        | The Forth .....  | [fɔːθ]        |
| Plymouth .....          | ['plɪməθ]          | Sheffield.....   | ['ʃeɪfɪld]    |

## V Reading

1 Read the text and explain the difference between Great Britain and the UK.

### THE UNITED KINGDOM

The United Kingdom (the UK) includes Great Britain and Northern Ireland, so the official name of the group of countries is the United Kingdom of Great Britain and Northern Ireland. The UK is surrounded by a lot of water: to the northeast is the North Sea; the Atlantic Ocean is to the northwest; and the Strait of Dover and the English Channel are to the south of this group of islands. The Strait of Dover is the narrowest part of the English Channel, and it is 32 km wide.

Great Britain consists of England, Scotland and Wales, and it forms the greater part of the British Isles. The British Isles are separated from the rest of Europe by water, and are situated to the northwest of Europe.

The population of the UK is 64.1 million people. The largest country in the UK is England. Its population is just over 53 million people.

There are several rivers in England. The longest is the Severn, but the most important is the Thames because boats can travel on it.

There are three parts in England: Northern England, the Midlands, and Southern England. Each part has its own beauty, and is very different from the other parts. Northern England, for instance, is famous for its many lakes.

London is the capital of England, Great Britain and the UK. It is one of the most important seaports



in the world. It has many wonderful places to visit and see, and many tourists visit them each year.

Other important cities in England are Birmingham, Liverpool, Manchester, Leeds, Sheffield and Bristol. Oxford and Cambridge are small cities, but they are famous for their universities. Stratford-upon-Avon is also small, but it is famous as the birthplace of William Shakespeare, a famous English poet and dramatist.

**VI Listening**

- 1 Listen to the information about Scotland, Wales and Northern Ireland. Match the places with the country.

**Places:** Belfast, Loch Ness, Cardiff, the Clyde, Glasgow, Ben Nevis, Edinburgh, highlands, lowlands.

**Country:** Scotland, Wales, Northern Ireland.

- 2 Speak about the Government of the UK.

**VII Grammar**

**Remember:**

**Geographical names with and without "the"**

The names of rivers, oceans, seas, ranges of mountains, groups of islands, deserts are used with the definite article "the":

the Thames   the Pacific Ocean   the Black Sea   the Alps   the Shetland Islands   the Sahara Desert

But single mountains, single islands and lakes do not take the article "the": Olympus, Cyprus, Lake Superior

The names of cities, countries and continents do not take the article "the" either:

Europe   Italy   London   Spain

But: the Hague [heɪg] – a city in Holland, the USA, the Ukraine, the UK, the Netherlands, the Argentine.

- 1 Fill in the article **the** where necessary:

- ... Nistru is the longest river in ... Moldova.
- Plenty of our students like to travel on their summer holidays either to ... Mediterranean Sea or to ... Carpathians.
- ... Constanța is the most important seaport on the coast of ... Black Sea.
- Lots of people in ... Africa suffer from different diseases.
- The *Titanic* with more than two thousand passengers on board was sailing to ... New York when it sank in ... Atlantic Ocean in 1912.
- ... Orkney Islands, ... Shetland Islands and ... Hebrides belong to ... Scotland.
- ... Great Britain consists of ... England, ... Scotland and ... Wales.

- 2 Say what countries you would like to travel to and why, using articles where necessary.

**VIII Writing**

- 1 Write sentences including the following groups of words:

- London, Thames, situated.
- Oxford, Cambridge, university, cities, famous.
- Great Britain, not long, many of them, rivers, deep.
- Most of, mountains, Scotland, not very high.
- The English, holidays, spend, Lake District.
- Glasgow, most important, Liverpool, London, Plymouth, Southampton, Portsmouth, seaports.

- 2 Group the words below in pairs of synonyms or antonyms: *attractive, authority, monarch, lowlands, rock, queen, narrow, highlands, king, stone, dense, to elect, thick, to choose, picturesque, power, wide*

**I Pronunciation**

*Read as quickly as you can:*

Madrid is the Capital City of Spain –  
 I know what I'll do if it only won't rain!  
 I'll set my new boat in full sail on the lake,  
 Commanded by Hawkins and Raleigh and Drake,  
 To conquer the Spanish Armada again.  
 Madrid is the Capital City of Spain ...

*(Eleanor Farjeon)*

*"Some are born great,  
 some achieve greatness."*

*William Shakespeare*



**II Conversational Formulas**

*In pairs, practise microdialogue when:*



- a) asking about something  
 Did you know about ...?  
 Have you heard about ...?  
 Have you got an idea about ...?



- b) answering  
 In fact, I did know about ...  
 I do know about ...  
 Yes, I have heard about ...  
 Yes, I've been told ...

**III Discussion Points**

*Answer the questions:*

1. What are the traits that define a personality?
2. When and how does a common man become a personality?
3. How can a national personality get worldwide recognition?
4. What personalities can you name?
5. Where is the monument in the picture placed?
6. What do you know about Ștefan cel Mare?
7. How do you understand the lesson quote?

**IV Vocabulary**

- 1 *Read and pronounce the words and phrases.  
 Use a dictionary to find their meaning.*

|                   |                        |                        |                     |                    |
|-------------------|------------------------|------------------------|---------------------|--------------------|
| <b>Nouns</b>      | devotion               | treasure               | fame                | commander-in-chief |
| <b>Verbs</b>      | to sentence<br>to gain | to defeat<br>to pierce | to wound<br>to fire | to recruit         |
| <b>Adjectives</b> | outstanding            | fearless               | skillful            |                    |

- 2 *Work in pairs. Match the words with their definitions:*

- |                |                                   |
|----------------|-----------------------------------|
| 1. to sentence | a) to win victory over            |
| 2. to defeat   | b) to pronounce punishment (upon) |
| 3. to pierce   | c) to acquire, to obtain          |
| 4. to gain     | d) to pass into; to penetrate     |
| 5. to wound    | e) to injure                      |
| 6. to recruit  | f) to enlist into an army or navy |
| 7. to fire     | g) to shoot (gun, bullet)         |

- 3 **In groups, form different parts of speech from the words:**  
*devotion, fame, to sentence, to defeat, to wound, to recruit, fearless, skilful*

e.g. devotion – to devote, devoted, devoting

**Use a dictionary, if necessary.**

## V Reading

- 1 **Read the text.**

### OLIVER CROMWELL



The dearest treasure of a country is its people. There is no country in the world which wouldn't be proud of its citizens.

One of the most outstanding historical personalities of England is Oliver Cromwell (1599-1658). He was the leader of the English Revolution that in 1642 turned into the Civil War between the king's and the Parliament's armies. At first, the Royalist forces gained the fight, then Cromwell made a radical change in the military strategy.

Cromwell was a strong man of middle stature, clever, and severe.

As to continue the battle against the King, Cromwell went to some eastern countries to recruit the best soldiers to complete his army. So, in 1645, the King's army was completely defeated by Cromwell's brave and skilled soldiers. The king was found guilty and he was sentenced to death.

Cromwell, in 1649, became the ruler of England, not as king, but as "Protector of the Commonwealth" for 10 years. His ruling brought England military glory and national power. It was Cromwell who united England, Scotland and Northern Ireland.

- 2 **Work independently. Find in the text synonyms for:**

|       |            |               |            |         |
|-------|------------|---------------|------------|---------|
| state | to win     | individuality | smart      | totally |
| globe | well-known | powerful      | courageous | fame    |

- 3 **Answer the questions on the text:**

- When did the Civil War break out?
- Between whom was the Civil War?
- What made Oliver Cromwell the best representative of the revolution?
- When did Cromwell become the ruler of England as Protector of the Commonwealth?

- 4 **Summarize the text.**

## VI Listening

- 1 **Listen to the text "Horatio Nelson."**

- 2 **Answer the questions:**

- Where did Nelson's first battle take place?
- What did the soldiers respect Nelson for?
- Where is Cape Trafalgar?
- What Nelson's well known words were written on the flagship?
- Where can people see his monument?

**VII Grammar****Remember:****POLYSEMY**

has to do with words having diverse meanings

e.g.

**to fire** – 1) to fire a gun (to shoot)  
2) to fire questions (to ask many questions quickly)  
3) to fire an employee (to dismiss)

**power** – 1) physical power (strength)  
2) power of speech (capacity)  
3) legal power (right)  
4) *western powers* (dominant states)  
5) hydroelectric/nuclear power (energy)

**ball** – 1) round object used in games (football)  
2) anything having a round shape  
3) the rounded part of the foot where toes join it  
4) a large formal event at which people dance

**1 Insert the appropriate words from the box above:**

- The Vienna Opera ... is an annual Austrian society event which takes place in the building of the Vienna State Opera.
- In ancient times people didn't know the Earth has the shape of a ... .
- The President of the country has the ... to name the ambassadors.
- After her illness she lost the ... to walk.
- Because of the world economic decline, lots of employees are ... in many countries.
- Little children always ... questions at their parents.

**VIII Writing**

**1 Using a dictionary, find the meaning of the polysemantic words: to capture, severe.**

**2 Write down all types of questions to the sentence.**

Admiral Nelson fought for England for the last time in 1805.

**3 Write a descriptive composition about a national personality our country is proud of, including his/her personal characteristics and achievements.**

**IX Additional Information***It's Interesting to Know*

– The monument to Ștefan cel Mare in Chișinău was erected by the prominent sculptor A. M. Plămădeală and the famous architect A. I. Bernardazzi in 1927. The Memorial House of A. M. Plămădeală (1888–1940) is on Bucharest Street.

– A. V. Shciusev, a famous architect, was born in Chișinău. He was the author of the Museum of Ethnography building. The Memorial House of A. V. Shciusev is on Shciusev Street.



## I Conversational Formulas

Use the phrases below in microdialogues:

*“America is the only place where miracles not only happen, but where they happen all the time.”*

*Thomas Wolfe*



- Can you tell me where ... ?
- How can I get to ... ?
- How do I get to ... ?
- When is the next flight to ... ?



- At the next corner.
- It's two blocks down.
- Go straight ahead.
- In two hours.

## II Discussion Points

1 As a class, speak about the seaports you know.

2 Brainstorm the info about the only seaport in Moldova.

3 Imagine you are in a seaport city. Call your friend and share impressions about it. Use as many adjectives as you can.

4 Think over the lesson quote and comment on it.

## III Vocabulary

1 Read and pronounce the words and phrases. Use a dictionary to find their meaning.

|       |  |                  |                   |                 |
|-------|--|------------------|-------------------|-----------------|
| Nouns | tip<br>settlement                        | gateway<br>trade | cargo<br>shipping | port<br>transit |
| Verbs | to purchase                              | to ship          |                   |                 |
|       | to light - lighted / lit - lighted / lit |                  |                   |                 |

2 Use the words from the box as to match the definitions:

- |                                       |   |
|---------------------------------------|---|
| a) the extreme end of a place         | e) goods transported by ships, planes ... |
| b) place where people live in         | f) harbour                                |
| c) the activity of buying and selling | g) to transport by ship                   |
| d) entrance to                        | h) to buy                                 |

**3** Learn to pronounce the following words you will meet in the text.

|                |            |                  |                  |
|----------------|------------|------------------|------------------|
| Singapore..... | ['sɪŋəpɔ:] | Manhattan.....   | [mæn'hætən]      |
| Bangkok.....   | ['bæŋkɔk]  | Dutch.....       | [dʌtʃ]           |
| Hong Kong..... | [hɔŋ 'kɔŋ] | Los Angeles..... | ['lɒs 'ændʒi:lz] |
| Tokyo.....     | ['təʊkiəʊ] | Spanish.....     | ['spæniʃ]        |
| Ellis.....     | ['elɪs]    |                  |                  |

**IV** Reading

**1** Read the texts.

**SEAPORT CITIES**

People got accustomed to using all existing means of transportation that connect regions and countries to each other. Transportation by sea is one of them. Many cities in different countries developed good maritime networks by building seaports. There are many important seaports cities in the world. In this lesson you'll find out some information about seaports cities like New York, Los Angeles and Singapore.

**NEW YORK**

New York City is geographically the largest and most populated seaport city in the USA. It is known for its history as a gateway for immigration to the United States and also for its status as a financial, cultural, transportation and manufacturing centre. New York was inhabited by Native American groups at the time the Dutch colonized the Manhattan area in 1624. The British took over Manhattan and the colony by annexation two years later. The Statue



of Liberty, a gift of France to the United States, was inaugurated on Ellis Island in the New York Harbour on October 28, 1886.

**LOS ANGELES**

Los Angeles, the second largest seaport city in the United States, with a population of 3.8 million people is the largest city in the Western United States. Los Angeles was founded on September 4, 1781 by the Spanish governor Felipe de Neve. It became a port of Mexico in 1821, following its independence from Spain. In 1848, Los Angeles and the rest of California were purchased from Mexico, and since then they became part of the USA. Los Angeles is a world centre of business, international trade, entertainment, culture, media, fashion, science, technology and education. As the home base of Hollywood, it is known as the "Entertainment Capital of the World."



The port of Los Angeles is located in San Pedro Bay, approximately 32 km South of downtown. The port complex occupies 30 km<sup>2</sup> of land and water.

**2** Correct the statements:

- a) Chicago is the largest city in the USA.
- b) Manhattan areas were colonized by the British in 1624.
- c) The Statue of Liberty was given as a gift to the US by Spain.
- d) Los Angeles is the smallest seaport in the USA.
- e) Hollywood is known as a world business centre.



**3 Answer the questions on the texts:**

- What is New York City known for?
- Who was New York inhabited by in 1624?
- When and where was the Statue of Liberty inaugurated?
- When and how did the British take over Manhattan?
- What is the largest seaport in the Western US?
- When and by whom was Los Angeles founded?
- When did it become a port of Mexico?
- When did Los Angeles and the rest of California become part of the USA?
- What is Los Angeles famous for?
- Where is the port of Los Angeles located?

**V Listening****1 Listen to the text "Singapore."****2 Listen to the text again and answer the questions:**

- Where is Singapore situated?
- Whose colony was it?
- What is its economy focused on?
- What is Singapore famous for?
- What can you say about its climate?
- How many airlines does the network of Singapore airport have?

**VI Grammar****Remember:**

The verb expressing **GENERAL TRUTH** and **FACTS** in the **REPORTED** clause doesn't move "one tense back."

| COMPARE  |  |
|--|--|
| Direct Speech  | Indirect Speech  |
| <p>The teacher <b>said</b>, "Los Angeles <b>was founded</b> on September 4, 1781."<br/>The teacher <b>said</b>, "The Singapore state <b>consists</b> of 63 islands."</p> | <p>The teacher <b>said</b> (that) Los Angeles <b>was founded</b> on September 4, 1781.<br/>The teacher <b>said</b> (that) the Singapore state <b>consists</b> of 63 islands.</p> |

**1 Report the following statements and questions:**

- The teacher asked, "Who can become the President of the USA?"
- One of the students said, "The Constitution of the USA was written more than 200 years ago."
- Radu said, "A person who wants to become the President in the USA must be at least 35 years old."
- The teacher said: "How many stripes and stars are there on the American flag?"
- The student said, "Singapore became a British colony on August 2, 1824."
- Victor said, "The flag of the USA is called stripes and stars."

**VII Writing****1 Make up 4 sentences, using the grammar above.****2 Put the words in the right order to form questions:**

- British colony, When, become, Singapore, did, a?
- is, What, the, Los Angeles, population, of?
- tourists, attracts, to, visit, New York, What?
- founded, was, When, Los Angeles, and, by, whom?
- many, are, There, important, big, and, sea ports, the, in, world, aren't, there?
- there, Are, ports, any, Moldova, in?

**3 Write a description of a seaport.**

**I Pronunciation**

*Read as quickly as you can:*

William the Conqueror, Ten-Sixty-six –  
 I know what I'll build after tea with my bricks!  
 I'll build a great castle with drawbridge and keep,  
 And arches through which I shall see, when I peep,  
 Saxon and Norman both up to their tricks ...  
 William the Conqueror, Ten-Sixty-six.

*(Eleanor Farjeon)*



*“A man’s house is his castle.”*

*Edward Coke*

**II Conversational Formulas**

*Pair work. Use the phrases below in microdialogues when asking for detailed information about your partner’s house.*



- Do you live in a block of flats or in a house?
- How do you like it?
- How long have you lived in it?
- How do you like the surroundings?



- I live in a ...
- It’s great!
- I like it very much.
- About ten years.
- Rather attractive.

**III Discussion Points**

- 1 *Imagine you are in the city. Look at the buildings around. Name the types of buildings and say what they are designed for.*
- 2 *Talk about your likes and dislikes referring to the place you live in.*
- 3 *Say what people are expected to be seen in: castles, hospitals, monasteries, universities, factories, shops, theatres, concert halls.*
- 4 *Say in what buildings you would expect to find the following rooms: reading room, waiting room, laboratory, gym hall, changing room, canteen, library, playroom.*
- 5 *What does the lesson quote mean to you?*

**IV Vocabulary**

- 1 *Read and pronounce the words and phrases. Use a dictionary to find their meaning.*

|                   |                        |                |                             |         |
|-------------------|------------------------|----------------|-----------------------------|---------|
| Nouns             | clay house             | concrete house | staircase                   | landing |
|                   | stone house            | wood house     | railing                     |         |
|                   | brick house            | cement         | stairs                      |         |
| Verbs and Phrases | to whitewash           |                | to put in doors and windows |         |
|                   | to lay the foundations |                | to drive/to hammer nails    |         |

**2 Work in pairs. Match the words with their definitions:**

- |                 |   |
|-----------------|---|
| 1. concrete     | a) type of earth that is soft when it is wet and hard when it is dry                |
| 2. stairs       | b) to paint walls white with a mixture of chalk and water                           |
| 3. clay         | c) blocks of baked clay that are used for building walls                            |
| 4. brick        | d) a substance used for building and made from cement, sand, small stones and water |
| 5. landing      | e) balustrade   |
| 6. railing      | f) a set of steps inside a building   |
| 7. staircase    | g) a set of stairs inside a building  |
| 8. to whitewash | h) an area at the top of a staircase, with rooms leading off it                     |

**3 Fill in the gaps with the words below:**

*whitewash, clay house, brick houses, foundations, drive, put in.*

- My grandparents used to live in a ... ..
- The ... of a house are usually laid of hard stone or concrete.
- After they had built the walls, the roof was put on and windows and doors were ... ..
- My three-year-old brother tried to ... a nail into the kitchen door.
- A clay house is considered to be old-fashioned in comparison with up-to-date ... ..
- Many people in the countryside still like to ... the walls of their houses.

**V Reading**

**1 Read the text. Find the key word that may be taken as a title of the text.**

I like to walk in the streets alone at night. I go down one street, cross over and go along another. The houses are all lighted. There are fires burning. People are sitting in the houses: men, women and children.

Houses are like people. The houses have faces. The windows are eyes. Some houses smile at you, others frown<sup>1</sup>. There are some houses that are always dark. People in them go early to bed. You hear no laughter from such houses, no one sings.

I know houses that always seem to whisper<sup>2</sup> to me. There are secrets hidden in such houses. They ask you

not to disturb<sup>3</sup> them. Many people are one thing inside their house and another in the street. Sometimes the secrets, hidden away behind the walls of houses, are simply sad, but sometimes they are exciting too.

There are evenings when I walk and see houses that all seem to be whispering to me. They are trying to tell me what I cannot understand.

I go past<sup>4</sup> a dozen houses, two dozen. They are glad houses where all the doors seem ready to open quickly. Some houses shout to me: "Come in!"

*(After Sherwood Anderson)*

<sup>1</sup> frown [fraun] v. – a se încrunta

<sup>2</sup> whisper ['wɪspə] v. – a șopti

<sup>3</sup> disturb [dɪs'tɜ:b] v. – a deranja

<sup>4</sup> past [pa:st] adv. – pe lângă

**2 Find in the text the following words: cross, like, walk, face, well, open.**

- Say what parts of speech they are and what they mean in the text.
- Use the same words in your own sentences as different parts of speech.

**3 Explain what the author means when saying that houses are like people: they have faces, they smile, frown, whisper, and shout, "Come in!"**

**4 Summarize the text.**

## VI Listening

- 1 Listen to the text. What is it about?
- 2 Listen again. Write down the keywords to describe:

- |                      |                                   |
|----------------------|-----------------------------------|
| a) the ground floor; | c) the laundry room (spălătorie); |
| b) the fireplace;    | d) the basement.                  |

## VII Grammar

**Remember:**

### THE PRESENT PERFECT PROGRESSIVE

The Present Perfect Progressive expresses an activity which began in the past and is still going on.

#### COMPARE

##### The Present Perfect (resultative)

The builders **have** already **installed** the central heating system.

##### The Present Perfect Progressive:

The builders **have been installing** the water, gas and electricity systems **since** last week.

- 1 Choose the right verb and put it into the Present Perfect Progressive:

*To work, to paint, to live (3), to rebuild, to build, to lay.*

- |  |   |
|--|---|
| a) They ... in this flat since 1990.                                 | – Oh, he ... on a new design for our new office block.                              |
| b) The builders ... the cottage foundations for 2 days.              | g) Most of the students ... in this modern hostel since they started their studies. |
| c) How long ... your cousin ... his cottage?                         | h) How long ... the Queen ... in the Buckingham Palace?                             |
| d) The painters ... the doors and windows since early morning.       |   |
| e) Our neighbours ... their house for months.                        |   |
| f) I haven't seen Mr. Popescu for a long time. Where's he, I wonder? |   |

## VIII Writing

- 1 Find the errors in the following sentences. Correct them.

- |  |   |
|--|---|
| a) They have been worked for half an hour.           | d) My sister has already been whitewashing the walls. |
| b) My cousin has built his cottage since last month. | e) Is John laying the foundations for 3 days?         |
| c) She is painting the house since morning.          | f) Hasn't the architect designing the house yet?      |

- 2 Insert the words consulting a dictionary:

*skyscrapers, palace, hostels, block of flats, castles, house.*

- |   |  |
|---|--|
| a) The Americans got used to their ... .  | d) Concerts are held in the famous National ... .                                  |
| b) A lot of students in Chişinău live in ... .                                      | e) The ... of my great grandparents is well preserved and looks rather attractive. |
| c) My uncle's family doesn't live in a detached house, they live in a modern ... .. | f) Many ... in Europe are transformed into museums.                                |

- 3 Write a short story in 50 words to illustrate the proverb "Every bird likes its nest".

**I Pronunciation**

Read as quickly as you can:

**The Sleeping Bag**

On the outside grows the furside,  
on the inside grows the skinside,  
So the furside is the outside, and  
the skinside is the inside.

There is no place  
like home.  
Proverb



**II Conversational Formulas**

Use the phrases below in microdialogues expressing preferences:



- Do you like ...?
- Don't you like ...?
- It is nice, isn't it ...?
- Isn't it fantastic ...?



- I think I'd prefer ...
- What I'd like is ...
- I really would like ...
- I like ... more than ...

**III Discussion Points**

- 1 Brainstorm a list of words to describe a children's room.
- 2 Describe a typical children's room.
- 3 In pairs, hold a discussion about the things you would like to be improved in your room.
- 4 Say how you understand the saying "Sweep before your own door".
- 5 Comment on the lesson quote.

**IV Vocabulary**

- 1 Read and pronounce the words and phrases.  
Use a dictionary to find their meaning.

|                               |                                 |   |  |
|-------------------------------|---------------------------------|---|--|
| <b>Nouns and Noun Phrases</b> | bedding<br>bed sheet<br>blanket | door knob/handle<br>built-in wardrobe<br>bunk bed/double-deck bed | socket<br>light switch<br>roller blind |
| <b>Verbs</b>                  | to furnish                      | to replace  |  |



standard lamp



quilt and pillows,  
quilt cover and  
pillowcases

- 2 Name the words that mean:

- |  |                                  |
|--|----------------------------------|
| a) sheets, blankets, and other covers used on beds                                   | d) two beds, one above the other |
| b) a tall electric light which stands on the floor                                   | e) thick covering for a bed      |
| c) something that obstructs <sup>1</sup> vision or keeps out light as a window shade | f) to put furniture in a room    |

<sup>1</sup> to obstruct [əb'strækt] v. - a bloca

- 3 Insert the missing words: *door knob, switch, bunk beds, pillow, roller blinds.*

- |  |   |
|--|---|
| a) A ... .. is a projecting part, usually rounded, forming the handle of a door, drawer. | c) Some rooms have ... .. instead of curtains.                  |
| b) In large families children sleep in ... .. .  | d) We use a ... to turn the light on and off.                   |
|  | e) My father falls asleep as soon as his head touches the ... . |

**V Reading**

1 Read Andrea's daily records in her diary and say why she is so happy with her room.

**DEAR DIARY,**

At last we have finished furnishing our new flat and now I am so happy to share my joy with you.

It's just luck that I have my own room, after sharing one with my sister. It is a special room, my favourite, I should say. If compared with the previous one, it's quite large. It has a large window, with bright silk curtains and Venetian blinds on it. The window looks out onto two apple trees in the garden. The room has a balcony, too. The window-sill and the balcony are full of plants that make the room and the balcony nice and fresh. The focal point of the room is the up-to-date furniture set where the stereo, computer, TV set and shelves with lots of books are concentrated. A large polished writing desk

with a lamp on it and a chair are opposite the furniture set. Next to the desk there is a modern comfortable sofa, a large armchair and a high standard lamp, a present from my cousin, between them. Above the sofa there is an old reproduction of Rembrandt in a gold painted frame inherited from my great-grandparents. A nice chandelier hangs down from the ceiling. On the polished parquet ['pa:keɪ] floor there is a large soft thick woolen carpet made at the well-known Floare Carpet factory. The walls are painted light blue.

The room, I must say, is cosy and comfortable with much light; a place where I can feel at ease.

I am so happy with it!

2 Work as a class. Find in the text synonyms for the following words:

- |                |                      |         |                 |
|----------------|----------------------|---------|-----------------|
| gift –         | suite of furniture – | big –   | pleased –       |
| to tell –      | bright –             | cosy –  | roller blinds – |
| contemporary – | near –               | table – | vis-a-vis –     |

3 Ask questions on the text.

**VI Grammar**

Remember:

**THE PAST PERFECT PROGRESSIVE**

**COMPARE**

| Present Perfect Progressive  | Past Perfect Progressive  |
|--|---|
| Ann <b>has been washing</b> the floor in her room for five minutes.<br>How long <b>has</b> uncle John <b>been furnishing</b> his son's room? | When Mum came home, Ann <b>had been washing</b> the floor in her room for five minutes.<br>How long <b>had</b> uncle John <b>been furnishing</b> his son's room when you visited him? |

1 Open the brackets using Present Perfect Progressive or Past Perfect Progressive:

- When mother entered the house, Andrieş (to dust) the furniture for ten minutes.
- Victor wanted to know how long the electrician (to install) the electrical items in the new flat.
- Sorin wants to know for how long his elder sister Angela (to paint) the walls in his room.
- Mother asked her son how long he (to play) computer games.
- Mum says father (to furnish) Nick's room since morning.

**VII Writing**

- Do ex. 9 p. 109 from the Supplement.
- Write a paragraph in 50 words on the topic of the lesson, using all the new words.

## I Let's Talk

- 1 *Some English tourists are visiting your school. When meeting them you have an opportunity to get information about their country through direct contact. Hold a discussion.*
- 2 *Insert the words given below the text.*

### GRIGORE VIERU – Symbol of National Dignity

Grigore Vieru is the greatest ... poet of our days. There is no other poet in Moldova who ever wrote so many poems ... to Mother, his ... land and its ... and especially to children. His poems ... motherland made him ..., ..., ... and loved by everybody. Grigore Vieru is also ... for his ... poems dedicated to our Roman ... opting for our language ... name, which is ... and its ... writing. Most of his poems

were turned into famous ... songs that are widely sung in Moldova and other European ... . Unfortunately we lost our ... and talented ... who in 2009 died after a car ... .



*devoted, accident, patriotic, national, Latin, countries, people, Romanian, famous, poet, honoured, origin, glorifying, great, well known, respected, historical, courageous, native*

- 3 *Find additional info about the following national celebrities. Discuss it in class.*

**Alexandru Donici**, (1806–1865), famous writer, born in the village of Stînca, at present called Donici. The writer's house is well preserved and turned into a museum.



**Alexie Mateevici**, (1888–1917), military priest, poet, author of the famous poem “*Limba Noastră*” that is now the State Anthem, born in the village of Zaim, south-west of Tighina. His family house is also well preserved and turned into a museum.

**Nicolae Testemițianu**, (1927–1986), famous surgeon, born in the village of Ochiul Alb, west of

Soroca. Now the Chișinău Medical University is named after him.

**Maria Bieșu** (1935–2012) was an extraordinary opera singer with an enormous chamber repertoire [‘repətwa:]. Her artistic excellence brought her international recognition.



**Dumitru Matcovschi** (1939–2013) was a greatly loved writer, poet and dramatist. He was a well-known personality of the cultural and artistic life of Moldova, being awarded high state distinctions for his outstanding merits.

- 4 *Brainstorm a list of seaport cities you know.*
- 5 *Say when we use the proverb “East or West – home is best”.*
- 6 *Work as a class. How important is it for you to have your own room?*

## II Grammar

### 1 Put the verbs from the brackets in the correct tense form.

- a) They (to furnish) the flat all day.
- b) My elder brother (to decorate) his room since morning.
- c) She (to live) in this city since childhood.
- d) The reporter asked the workers how long they (to do) the finishing work in the newly built house.
- e) You already (to move) into a new flat?
- f) My uncle (to replace) the furniture in his flat since early morning.
- g) She said she (to live) in the city for ten years.
- h) When I came in, Nick (to look) for information about Ștefan cel Mare for half an hour.

### 2 Report the sentences:

- a) The teacher said, "The UK consists of Great Britain and Northern Ireland."
- b) The teacher said, "What does the UK consist of?"
- c) The people said, "The continent of America was discovered in 1492 by Columbus."
- d) The teacher said, "Where is Singapore situated?"
- e) Nick said, "Dad, our grandparents' house was built in 1950, wasn't it?"
- f) The teacher said, "Mihai Eminescu was born on January 15, 1850."
- g) The student said, "The House of Parliament of Moldova was devastated on April 7, 2009."

### 3 Give the geographical names with and without "the".

### 4 Write the names of nationalities and languages of the following countries, using a dictionary:

| Country  | Nationality | Language |
|----------|-------------|----------|
| England  | _____       | _____    |
| Ireland  | _____       | _____    |
| Wales    | _____       | _____    |
| Scotland | _____       | _____    |
| Turkey   | _____       | _____    |
| Germany  | _____       | _____    |
| France   | _____       | _____    |

## III Additional Information

### *It's Interesting to Know*

- The Loch Ness monster is a real attraction for people from all parts of Britain and from many other countries. A museum of the Loch Ness monster was opened in Scotland that has more than four thousand written reports and drawings of Nessie made by those people who have "seen" it.
- The most ancient city in England is Chester.
- There is one British island which has but one house on it: this is Jethou [ʒə'tu:], one of the Channel Islands.
- \*\*\*
- The largest ocean is the Pacific; it contains 47.31 per cent of the world's ocean water and covers 66.030.124 square miles.



**I** **Pronunciation**

*Read as quickly as you can without making mistakes.*

Miss Tracher the teacher  
who married a preacher.  
The news tried to feature  
this preacher-wed teacher,  
but just couldn't reach her,  
Miss Tracher the teacher.



*"The roots of education are bitter, but the fruit is sweet."*

*Aristotle*

**II** **Conversational Formulas**

*Read the phrases below that discuss school. Use them in dialogues.*



Where do you go to school?  
What classes do you take?  
What is your favourite class?  
I really like school. How about you?



I attend a gymnasium in...  
I like to study...  
My favourite class is...  
I really enjoy...

**III** **Discussion Points**

*Answer the questions:*

1. Why do we go to school?
2. Can you describe different types of schools?
3. Can you be too old to learn?
4. What would happen if we didn't have schools?

**IV** **Vocabulary**

**1** *Read and pronounce the words and phrases. Use a dictionary to find their meaning.*

|                               |  |   |                                      |
|-------------------------------|--|---|--------------------------------------|
| <b>Nouns and Noun Phrases</b> | ten-point scale<br>head-master (Br)/principal (Am)<br>head-mistress (Br)<br>proficiency    | attendance<br>school-leaver/graduate<br>boarding school<br>form (Br.)/grade (Am.) | mark (Br)/grade (Am)<br>syllabus     |
| <b>Verbs and Phrases</b>      | to provide education<br>to be at the top (head) of the class<br>to be at the bottom (foot) | to pass<br>to hand in<br>to catch up with   | to lag/fall behind<br>to cut lessons |
| <b>Adjectives</b>             | compulsory   | well-disciplined/behaved (ill-behaved)  | vocational                           |

**2** *Work as a class. Explain what the following words mean:*

- a) general education      b) gymnasium      c) schooling      d) a course of study      e) lyceum  
f) basic      g) private      h) public      i) education      j) preschool

**3** *Work in pairs to match the words with their definitions.*

1. head-master
2. graduate
3. attendance
4. general education
5. compulsory
6. vocational
7. proficiency
8. syllabus

- a) person who finishes school
- b) skill, ability or expertise
- c) the director of a school
- d) education directed toward a particular trade or profession
- e) presence
- f) list of classes offered at a school
- g) obligatory, mandatory
- h) result of instruction, training or study

**V** *Reading*

**1** *Based on the title of the text below, what do you think the text is about?*

**2** *Scan the text to see if you guessed correctly.*

### EDUCATION IN MOLDOVA

By law, children in Moldova must receive compulsory education at state schools from the ages of 7 to 16. Since the late 1990s, private education has also become available in Moldova.

Most children, before attending school, go to kindergartens that provide preschool education based on playing, singing, practical activities such as drawing, and social interaction as part of the transition from home to school.

During the first four years of schooling, children get a primary-school education that serves as basis for further studies. Primary education ensures a smooth transition to secondary education.



Secondary school is the next step up from primary school. The course of secondary education includes two stages: gymnasium and lyceum. The gymnasium stage is compulsory for students. During this course of studies, pupils get effective education. On finishing the 9<sup>th</sup> Form, certificates are given to pupils who may then go to colleges, vocational or technical schools, or may continue their secondary education at lyceum.

The three-year lyceum stage offers pupils the opportunity to choose a direction of study according to their individual interests and abilities. On completing the lyceum course of studies, diplomas are handed to the graduates who may then go to universities.

**3** Based on the text, state whether the following sentences are true (T), false (F), or there isn't enough information to say.

1. Children receive full-time education from the ages of 4 to 14.
2. Primary schools are not separated from secondary schools.
3. The first stage of secondary education is gymnasium.
4. The second stage of secondary education is university.
5. The gymnasium stage is compulsory.
6. Diplomas are given to graduates of lyceum.
7. After the 9<sup>th</sup> Form, students may go to university.

**4** Find synonyms in the text for the following words.

- |        |               |              |            |         |             |
|--------|---------------|--------------|------------|---------|-------------|
| a) get | b) study      | c) teaching  | d) contain | e) form | f) majority |
| g) end | h) obligatory | i) schooling | j) select  | k) big  |             |

## VI Grammar

### WORDS WITH FIGURATIVE MEANINGS

**Figurative sense** – a more abstract, imaginative, metaphorical, not literal, symbolic, ironic, hyperbolic meaning than its direct one.

1. We were scared to death, figuratively speaking.
2. She was imprisoned by him, figuratively speaking.
3. The news totally killed him.
4. She is such a sweet!
5. I think your school is really cool.

**1** In your own words, share what the figurative meaning of the underlined words is. Use a dictionary if you don't know the words.

1. Sally was really sick, she looked like a ghost.
2. With so much homework, I'm a slave to the 7<sup>th</sup> Form.
3. I got a 10 in English. I'm flying high.
4. In April, my classroom is always so cool.
5. I think it's really cool that you are in the school play.
6. That test was a snap (träsnet).
7. Bridgette always has her nose in a book.

**2** Look at the lesson quote and discuss the figurative language used in it.

## VII Listening

**1** Listen to the dialogue and answer the questions.

1. What are the words with figurative meaning in the dialogue?
2. What do the figurative words mean in the dialogue?
3. Why does Billy want to study with Caroline?
4. What suggestion does Billy make to simplify their homework?
5. Does Caroline like her English class?
6. Do you think Caroline wants to spend time with Billy?

## VIII Writing

**1** Write a paragraph of 50 words to say if you like school or not, and explain why.

**2** If you were the director of your school, what would you do that is different from what is done now? Write a list of 10 things you would change.

**I Pronunciation**

*Read as quickly as you can without making mistakes.*

If the singular's this and the plural is these,  
Should the plural of kiss ever be keese?  
Then one may be that and three would be those,  
Yet hat in the plural would never be hose,  
And the plural of cat is cats, not cose.



**II Conversational Formulas**

*Read the phrases below and say where in school you would use these phrases.*



Excuse me, I'm looking for...  
It's really important that I find...  
How do I find...?  
Can I find...in that direction?



Pardon me, but do you know where ... is?  
I'm trying to find...  
I'm trying to get to...  
How do I get to...?

*“Those who know nothing of a foreign language, know nothing of their own.”*

*Goethe*

**III Discussion Points**

*Answer the questions:*

1. Why is English an important language to study?
2. What are some ways that you can learn English on your own?
3. Should everyone in Moldova have to learn English?
4. What other languages do you know? How did you learn them?

**IV Vocabulary**

**1** *Read and pronounce the words and phrases. Use a dictionary to find their meaning.*

|                          |                                       |                                   |                          |
|--------------------------|---------------------------------------|-----------------------------------|--------------------------|
| <b>Nouns</b>             | device<br>visual aids<br>command (of) | skill<br>requirement<br>technique | opportunity<br>equipment |
| <b>Verbs and Phrases</b> | to succeed                            | to progress                       | to brush up<br>to ignore |

**2** *Use the words below instead of the underlined words in the following sentences: command of, to pronounce, to succeed, to progress, to brush up*

1. Victoria's friend needs to improve her English before her visit to Great Britain.
2. The teacher is proud of our strong knowledge of English.
3. He managed to do a lot of work on his English presentation.
4. The study of English advanced a lot with the Internet.
5. Our English teacher makes us practise saying words in class.

**V Reading****1 Read about some tips for improving your understanding of English, and then answer the questions.**

Learning a new language can be very interesting and difficult at the same time. In Moldova, many pupils only have two foreign language classes per week until they go to lyceum. It is very hard to try to learn a foreign language in such a short period of time per week, but there are some things that you can do on your own if you want to improve your English or any other language.



- Practise speaking in front of a mirror at home. This lets you see how you move your mouth to pronounce new or difficult words.
- Do your homework. This will give you extra practice using English even if nobody in your house speaks it.
- Make a pen pal friend through video games or through school who speaks English.
- If you meet someone who speaks English, don't be shy. Ask that person to be patient and to speak to you in English.
- There is a wide variety of language software on the Internet like Duolingo.com or Livemocha.com that can help you learn vocabulary.
- Read an easy book in English, and look up the words you don't know in a dictionary.
- Watch cartoons in English with subtitles in English so that you can practise your listening and reading.

This is just a short list of tips that you can use to improve your English. If you really want to learn, there are many ways to build your proficiency.

**2 Working individually, answer the questions. Choose the answer that is best for you.**

- a) How do you like to learn English in class?
- |                     |                      |
|---------------------|----------------------|
| - working alone     | - working in pairs   |
| - working in groups | - working as a class |
- b) When do you memorize words better?
- |                         |                                      |
|-------------------------|--------------------------------------|
| - when I see them       | - when I hear them                   |
| - when I look at charts | - when I look at pictures with words |
- c) When do you think about grammar?
- |                     |                               |
|---------------------|-------------------------------|
| - when I am reading | - when I do grammar exercises |
| - when I am writing | - when I am speaking          |

**3 Working in pairs, discuss the tips in the text. Are there any that you definitely would like to try? Are there any that you don't feel able to try? Explain why you feel that way.**

## VI Listening

- 1 Listen to the dialogue and explain why Steve is impressed with the Moldovan English classroom.
- 2 After listening to the dialogue, work with a partner and give your opinions on the following questions.
  - a) How important are teachers to your learning of English?
  - b) How does your English classroom compare to the one in the dialogue?
  - c) Do you think modern technology is important when learning English?
  - d) How does your school use computers and the Internet for learning English?

## VII Grammar

**Remember:**

The Subjunctive Mood after **WISH**  
**Remember** how to express a wish referring to the present or future.

| COMPARE   |   |
|---|---|
| <p style="text-align: center;"><b>The Indicative Mood</b></p> <p>a) <b>It's a pity</b> we don't have enough visual aids in our school.</p> <p>b) <b>It's a pity</b> I don't succeed in foreign languages.</p> <p>c) <b>What a pity</b> I can't do this job.</p> <p>d) <b>It's a pity</b> my mother is not a teacher of English.</p> <p>e) <b>What a pity</b> we'll not go on a trip tomorrow.</p> | <p style="text-align: center;"><b>The Subjunctive Mood after wish</b></p> <p>a) I <b>wish</b> we had enough visual aids in our school.</p> <p>b) I <b>wish</b> I succeeded in foreign languages.</p> <p>c) I <b>wish</b> I could do this job.</p> <p style="text-align: center;"><b>After the verb wish "were" is used for all persons:</b></p> <p>d) I <b>wish</b> my mother were a teacher of English.</p> <p>e) I <b>wish</b> we went (would go) on a trip tomorrow.</p> |

- 1 Express a wish transforming the sentences below.
  - a) It's a pity I can't pronounce all English sounds well. – I **wish** ...
  - b) It's a pity I'm not a student of your school. – I **wish** ...
  - c) My friend won't practise English every day. – He **wishes** ...
  - d) We don't have portraits of American writers in our English Classroom. – We **wish** ...
  - e) Not all the students have a good command of English. – The teacher **wishes** ...
  - f) Sorin always makes mistakes when pronouncing geographical names. – The teacher **wishes** Sorin ...
  - g) I'm sorry I can't understand the task. – I **wish** I ...
  - h) It's a pity he is not attentive at the lesson. – The teacher **wishes** he ...

## VIII Writing

- 1 Answer the following questions in writing:
  - a) What helps you to improve your English skills?
  - b) Who in your class speaks English the best? Why?
  - c) Would you like to become an English teacher? Why or why not?
- 2 In 50 words, write a short letter to persuade a younger student of the importance of learning English.

**I Pronunciation**

*Read as quickly as you can without making mistakes.*

Dearest creature in creation,  
Study English pronunciation.  
I will teach you with my verse,  
Sounds like corpse<sup>1</sup>, corps<sup>2</sup>, horse and worse.

<sup>1</sup> corpse [kɔ:ps] n. – cadavru

<sup>2</sup> corps [kɔ:] n. – corp (diplomatic)



*"The limits of my language are the limits of my world."*

*Ludwig Wittgenstein*

**II Conversational Formulas**

*Read and practise saying the phrases that you would use to discuss and debate:*



I see your point, but...  
Normally I would agree, however...  
You have some good arguments.  
I think it's important to consider...



I completely disagree.  
I strongly disagree. Rather...  
Perhaps you should consider...  
Have you thought about...?

**III Discussion Points**

- 1 *What clubs or after school activities do you belong to?*
- 2 *Does your school have an English club? Do you attend it?*
- 3 *Brainstorm about different kinds of things you can do at an English club meeting.*
- 4 *Discuss the lesson quotation. What does it mean to you?*
- 5 *What do you know about English-speaking clubs?*

**IV Vocabulary**

- 1 *Read and pronounce the words and phrases. Use a dictionary to find their meaning.*

|              |                          |                            |           |               |           |
|--------------|--------------------------|----------------------------|-----------|---------------|-----------|
| <b>Nouns</b> | aim/goal/purpose         | debating                   | badge     | membership    | mastery   |
| <b>Verbs</b> | to promote<br>to achieve | to facilitate<br>to expect | to review | to comprehend | to enable |

- 2 *Work as a class. Discuss the meaning of the following words: communication, effective, responsibility, potential, to list, to select, to coordinate, except, fluency.*

- 3 *Match the words with their definitions:*

- |                     |   |
|---------------------|---|
| 1. badge            | a) the thing that an action or plan is intended to achieve              |
| 2. membership       | b) a discussion in which people express different opinions on a subject |
| 3. aim/goal/purpose | c) emblem   |
| 4. debating         | d) the fact or state of being a member of an organization               |
| 5. to promote       | e) to succeed in obtaining something                                    |
| 6. to achieve       | f) to help the progress of  |

**4** Use the words *comprehend, from time to time, to review, mastery, expected, to facilitate* instead of those underlined in the sentences below:

- Guests from abroad visit our English Speaking Club occasionally.
- Nick tried to understand the idea of the story.
- The class/form master supported the club president's initiative.
- In his letter, my friend Billy highly appreciated my good skills in grammar.
- Shall we revise the list of the equipment we need for our English Classroom?
- The members of the club awaited the speaker's arrival.

**V** **Reading**

**1** Read the text and be prepared to say if an English Speaking Club sounds interesting to you.

English clubs that are being opened in many schools are part of a specially designed programme to promote learning the English language, facilitate the debate of ideas, and provide opportunities for interaction between the learner and a teacher or outside guests. Such clubs help make learning more enjoyable. The primary goal of these clubs is to enable pupils to develop confidence in practising English and encouraging them to enjoy the studying process.

The members of the club wear their badges proudly. Each club should have a president, a secretary to take notes, and an executive committee to make decisions about the direction of the club. The teacher's role is to

facilitate the club's activities. Guests, if available, are sometimes invited to interact with club members.

Club activities help members develop skills to comprehend, predict and express ideas, and also to interview, write letters, prepare advertisements, etc.

Another purpose of English club activities is to improve pupils' vocabulary in the language, familiarize them with idioms and expressions, increase their creativity, and generate logical and critical thinking. Such activities are meant for the pupils of primary and secondary levels.

In an English club, pupils get a chance to practise many different skills in different circumstances.





**2 Find the words in the text that mean the following:**

- |   |                             |
|---|-----------------------------|
| 1. chance, possible situation           | 4. to tell about in advance |
| 2. something pleasant                   | 5. to enlarge               |
| 3. the person with the highest position | 6. to ask questions         |

**3 Work in pairs. Ask each other questions to fit the answers.**

- The club members wear badges.
- The teacher's role is to facilitate the club's activities.
- English club members practise different skills.
- Club activities are meant to improve pupils' language, increase creativity and generate critical thinking.

**4 Find in the text synonyms for the following words:**

|            |           |            |
|------------|-----------|------------|
| curricula  | a visitor | council    |
| to discuss | learning  | understand |
| chance     | do        | actions    |

## VI Grammar

### The Subjunctive Mood after **if**

**Remember:**

Observe the form of the verb after **if** expressing an **imaginary, impossible** or **improbable** situation when referring to the present and future.

| COMPARE AND REMEMBER  |  |
|---|--|
| Expressing<br>Regrets and Wishes  | Expressing<br>Imaginary situations   |
| <p>a) What a pity I am not a member of the English speaking club.<br/>– I <b>wish</b> I <b>were</b> a member of the English speaking club.</p> <p>b) It's a pity I can't visit an English speaking country.<br/>– I <b>wish</b> I <b>could</b> visit an English speaking country.</p> <p>c) My sister is very sorry she doesn't have a possibility to interact with the club members.<br/>– My sister <b>wishes</b> she <b>had</b> a possibility to interact with the club members.</p> <p>d) What a pity Denis will not be present at the club meeting.<br/>– I <b>wish</b> Denis <b>were</b> present at the club meeting.</p> | <p>– <b>If I were</b> a member of the English speaking club, I <b>would</b> improve my vocabulary.</p> <p>– <b>If I could visit</b> an English speaking country, I <b>would have</b> a chance to master my English.</p> <p>– <b>If my sister had</b> a possibility to interact with the club members, she <b>would learn</b> to prepare advertisements.</p> <p>– <b>If Denis were</b> present at the club meeting, he <b>would share</b> his experience.</p> |

**1** *Open the brackets expressing wishes and regrets.*

- a) It would be nice if we (to speak) foreign languages.  
 b) If Eliza (to improve) her pronunciation, she (not to speak) so terribly.  
 c) If I (not to develop) language skills, I (not to succeed).  
 d) If the club (to have) more activities, its prestige would greatly increase.
- e) What you (to do) in your school if you (to be) its head-master?  
 f) If all of you (to watch or to read) the play **Pygmalion** you (to understand) how important it is to speak a language perfectly.  
 g) What you (to do), if you (to be) the club president?

**2** *Pay attention to suffixes and prefixes in word building. Give other examples. Work in pairs.*

|                |               |               |             |            |             |
|----------------|---------------|---------------|-------------|------------|-------------|
|                | -ive          | -tion         |             | -able      | -tion       |
| to select      | selective     | selection     | to delegate | delegable  | delegation  |
| to expect      | expective     | expectation   | to expect   | expectable | expectation |
| to coordinate  | coordinative  | coordination  | to achieve  | achievable | -           |
| to communicate | communicative | communication |             |            |             |

|         |            |             |               |                 |           |             |
|---------|------------|-------------|---------------|-----------------|-----------|-------------|
|         | -ful       | -less       |               | un-, in-, ir-   |           |             |
| purpose | purposeful | purposeless | communicative | uncommunicative | definite  | indefinite  |
| aim     | aimful     | aimless     | effective     | ineffective     | reparable | irreparable |

## VII Listening

**1** *Listen to the poem 'Grammar In Rhyme' and be ready to talk about the different parts of speech in English.*

**2** *After listening to the poem, work with a partner to answer the following questions.*

- a) What is the difference between an adjective and an adverb?  
 b) What does an interjection show?  
 c) What do conjunctions do?  
 d) What are the three different articles?  
 e) What is a noun?  
 f) What parts of speech are "quickly", "well" and "good"?

## VIII Writing

**1** *Rewrite the sentences according to the example.*

**Example:** I wish I stayed in London for one year.  
 If I stayed in London for one year, I would practise English.

1. I wish I were present for the English club.  
 2. Our teacher wishes we improved our knowledge.  
 3. She wishes she spoke to her teacher about the matter.  
 4. They wish they spoke English better.  
 5. He wishes he were a teacher of English.  
 6. We wish we were in England now.

**2** *Imagine that you are a member of an English-speaking club. Write a short letter to your pen-friend about an activity that you would like.*

**I** Pronunciation

*Read as quickly as you can without making mistakes.*

A twister of films  
once twisted his twist  
so the gist of the film  
was a twist in a twist.



*“A movie star is not an artiste, he is an art object.”  
Richard Schickel*

**II** Conversational Formulas

*Read and practise saying the phrases that you would use to express excitement or enthusiasm:*



Wow! That’s exciting.  
That’s sensational!  
It was fantastic!



I’m excited by...  
It was amazing!  
It’s really terrific!

**III** Discussion Points

- 1 *Why do we go to see a film at the cinema?*
- 2 *What was the last film you saw? Did you like it? Why or why not?*
- 3 *Discuss the lesson quotation. What does it mean to you?*
- 4 *What can we learn from watching films?*
- 5 *What do you already know about how films are made?*

**IV** Vocabulary

- 1 *Read and pronounce the words and phrases. Use a dictionary to find their meaning.*

|                               |   |   |   |
|-------------------------------|---|---|---|
| <b>Nouns</b>                  | news reel<br>popular science film<br>viewers/audience<br>script | feature film<br>soap opera (film)<br>script writer<br>film director | film producer<br>dubbing<br>film/cinema-goer<br>pictures (Br.)/movies (Am.) |
| <b>Verbal Phrases</b>         | to shoot/make a film  | to screen a film  | to be on  |
| <b>Adjectives and Adverbs</b> | thrilling   | astonishing   | marvellous  |
| to shoot – shot – shot        |   |   |   |

- 2 *Work in groups. Explain what the following words mean:*

|                      |                        |                  |               |
|----------------------|------------------------|------------------|---------------|
| documentary (film) – | comedy –               | talented actor – | fascinating – |
| educational film –   | colour film –          | valuable –       | disgusting –  |
| detective film –     | black-and-white film – | superb –         | impressive –  |
| adventure film –     | film star –            | exciting –       | to prefer –   |

**3 Work in pairs. Match the words with their definitions:**

- |                         |   |
|-------------------------|---|
| 1. soap opera           | a) a short cinema film of news  |
| 2. scenario/script      | b) stories about imaginary future development in science                    |
| 3. script-writer        | c) a full-length cinema film with an invented story and professional actors |
| 4. news reel            | d) a daily or weekly continuing television story which is about daily life  |
| 5. dubbing              | e) a surface on which a cinema film is shown                                |
| 6. feature film         | f) a writer of scripts for films, broadcasts, etc.                          |
| 7. science fiction film | g) a written description of the action to take place in a film              |
| 8. screen               | h) more advanced or complex than others                                     |
| 9. sophisticated        | i) changing the original spoken language of a film, show, etc.              |

**V Reading**

**1 Read the text and be prepared to say if you like or dislike the idea of using films in class.**

Watching films is one of various modern teaching resources. Children are great film-goers, and when a teacher announces they will watch a film dedicated to a certain topic, they are always enthusiastic. The popularity of a film itself depends on the viewing children's ages and the topic. Pupils can watch popular educational, documentary, musical and other films as specified in each subject's curriculum.

Watching films is a powerful educational tool that can become a gateway to exploring complex ideas. It opens children's eyes to other ways of looking at the world and helps them understand it better. The power of watching films at school is great. It may develop critical thinking skills, and stimulate effective round-table discussions.

When watching films, children usually learn about the films' producers, stars, directors, cameramen, etc.

**2 Find in the text synonyms for the words:**

|              |             |              |               |
|--------------|-------------|--------------|---------------|
| at present – | big –       | passionate – | debates –     |
| different –  | film fans – | movie –      | efficient –   |
| to contain – | devote –    | to be able – | abilities –   |
| schooling –  | theme –     | instrument – | to find out – |
| kids –       | definite –  | entrance –   | universe –    |

**3 Find in the text antonyms for the words:**

|                 |           |               |          |
|-----------------|-----------|---------------|----------|
| never –         | unknown – | indifferent – | seldom – |
| similar –       | weak –    | unpopular –   | teach –  |
| learning –      | close –   | small –       | adults – |
| old-fashioned – | worse –   | ineffective – |          |

**4 Work in pairs. Answer the questions about the text.**

1. Why are children enthusiastic about watching films?
2. Why does the age of a child effect what he/she likes to watch?
3. What films can children watch in their out-of-school time?
4. How does watching films stimulate pupils' thinking?
5. What do children learn from watching films on various subjects?

**VI Grammar****Remember:**

| WHAT  | WHICH  |
|---|--|
| is used when there is rather a large choice and it is not clear how many possibilities there are.                       | is, as a rule, used when there is a limited choice (from two to five possibilities).                             |
| <b>WHICH</b> can be followed by <b>of</b> , but <b>WHAT</b> cannot.<br><b>WHAT</b> is followed by a noun and a pronoun. |  |
| <i>e. g.</i> <i>What colour are her eyes?</i><br><i>What perfumes does she use?</i>                                     | <i>Which colour do you like best the green or the blue one?</i><br><i>Which of you has watched the new film?</i> |

**1 Fill in with which or what:**

- ... dress shall I wear, the red or the blue one?
- ... flowers do you like?
- Ask him ... one he will choose.
- Say ... of you wants to become a cinema star.
- ... of these hats is yours?
- ... films does he like?
- ... of the film stars is your favourite?
- ... thriller have you recently watched?

**VII Writing****1 Rewrite the sentences leaving out the words that are not needed.**

**Example:** They said they didn't like eat films of about politics.  
 They said they didn't like films about politics.

- Watching of films is not a good way of playing learning interesting things.
- Why do have children enjoy and cartoons and horror films?
- My cousin is Dorin has a lot of much cassettes.
- When my dad doesn't watches detective stories films, he is doesn't hear or see anybody.
- Sophia Loren was has recognized as one of the most beautiful film stars of the 20th century.

**2 Write a film review of a film you've seen recently. Be sure to include information about the director and the stars.****3 Look at the pictures and say:**

- what films the scenes are taken from;
- who the main characters are;
- who played the main roles.



**I Pronunciation**

*Read as quickly as you can without making mistakes.*

When Mother's Day came on Sunday  
 We wanted to make it a fun day.  
 We all love our mother,  
 Me, my sister and brother,  
 So we made her an ice cream sundae<sup>1</sup>.

<sup>1</sup> sundae [ˈsʌndeɪ] n. – înghețată cu frișcă, nuci, fructe



*“What the mother sings to the cradle goes all the way down to the coffin.”*

*Henry Ward Beecher*

**II Idiomatic Expressions**

*Read the following expressions and match them to their meanings.*

- |   |   |
|---|---|
| 1. necessity is the mother of invention | a) the biggest or the first of something          |
| 2. at her mother's knee                 | b) to understand something, you have to try it.   |
| 3. experience is the mother of wisdom   | c) very ugly                                      |
| 4. mother of all...                     | d) learned at an early age                        |
| 5. a face only a mother could love      | e) If you need something badly, you'll create it. |

**III Discussion Points**

- 1 *Why do we celebrate Mother's Day?*
- 2 *Discuss the lesson quotation. What does it mean to you?*
- 3 *List some things that your mother does for you every day.*
- 4 *How do mothers make us feel special?*

**IV Vocabulary**

- 1 *Read and pronounce the words and phrases. Use a dictionary to find their meaning.*

|                          |                                       |   |                                   |                          |
|--------------------------|---------------------------------------|---|-----------------------------------|--------------------------|
| <b>Nouns</b>             | affection (for)<br>patience           | sake<br>fault   | bosom/breasts<br>anxiety          | cradle<br>disappointment |
| <b>Verbs and Phrases</b> | to tease<br>to nurse<br>to argue with | to mind (smth./doing smth.)<br>to forgive (smb. for smth.)<br>to keep the house | to share joys/sorrows (with smb.) |                          |
| <b>Adjectives</b>        | trifling                              | tender  | sensitive                         | sensible                 |
|                          | to forgive – forgave – forgiven       |   |                                   |                          |

- 2 *Identify the meaning of the following words:*

|             |               |               |             |             |
|-------------|---------------|---------------|-------------|-------------|
| directly –  | to proclaim – | to endure –   | to honour – | sacrifice – |
| to ignore – | official –    | to dedicate – | to suffer – |             |

**3 Work in pairs. Form different parts of speech adding the following suffixes: -ness, -ion; -ment; -able; -tion; -ly.**

|                            |                        |                         |
|----------------------------|------------------------|-------------------------|
| to argue – (n) ...         | to affect – (n) ...    | to disappoint – (n) ... |
| to direct – (n), (adv) ... | to honour – (adj) ...  | to dedicate – (n) ...   |
| love – (adj, adv) ...      | to forgive – (adj) ... | kind – (n) ...          |

**4 Match the words with their definitions:**

|                  |   |
|------------------|---|
| 1. anxiety       | a) a feeling of fondness for another person |
| 2. to argue with | b) gentle and caring feelings               |
| 3. to mind       | c) a small box-shaped bed for a baby        |
| 4. fault         | d) an error or mistake                      |
| 5. sake          | e) benefit, interest                        |
| 6. cradle        | f) to obey, to follow                       |
| 7. tender        | g) to try hard                              |
| 8. to strive     | h) to disagree with somebody (angrily)      |
| 9. affection     | i) a feeling of nervousness                 |



**V Reading**

**1 Read the poem and say what it means to respect one's mother.**

**I MUST NOT TEASE MY MOTHER**

I must not tease my mother;  
 For she is very kind;  
 And everything she says to me  
 I must directly mind;  
 For when I was a baby  
 And could not speak or walk,  
 She let me in her bosom sleep,  
 And taught me how to walk.

I must not tease my mother;  
 And when she likes to read,  
 Or has a headache, I will step  
 Most silently indeed:  
 I will not choose a noisy play,  
 Nor trifling troubles tell,  
 But sit down quiet by her side,  
 And try to make her well.



I must not tease my mother:  
 I've heard dear father say,  
 When I was in my cradle sick,  
 She nursed me night and day;  
 She lays me in my little bed,  
 She gives me clothes and food  
 And I have nothing else to pay  
 But trying to be good.

I must not tease my mother,  
 She loves me all the day,  
 And she has patience with my faults,  
 And teaches me to play.  
 How much I'll try to please her,  
 She every hour shall see;  
 For should she go away or die,  
 What would become of me?

*By Mrs. Siquoney*

**2 Learn the poem by heart.**

**3** *Work in groups. Find in the poem synonyms for the following words:*

|                |          |               |                 |
|----------------|----------|---------------|-----------------|
| annoy/bother – | talk –   | unimportant – | problem –       |
| generous –     | go –     | mistake –     | to look after – |
| follow –       | permit – | quiet –       | of course –     |
| select –       | train –  |               |                 |

**4** *Work as a class. Find in the poem antonyms for the following words:*

|            |           |           |              |
|------------|-----------|-----------|--------------|
| rude –     | stay –    | live –    | everything – |
| nothing –  | wake up – | hate –    | come –       |
| grown up – | noisy –   | healthy – | bad –        |

**5** *Independent work. Find in the poem the lines where the child:*

- shows his care for his mother;
- speaks how mother nursed him;
- speaks about mother's patience;
- explains why he has to directly mind mother's words.

## VI Grammar

**Remember:**

**DO**  
as a substitute of the main verb.

- E. g.
1. Some children happen to tease their mothers, but I never **do**.
  2. My little sister doesn't share toys with other kids, but my brother **does**.
  3. Steve sometimes argues with his parents, but his brother **doesn't**.
  4. Gabriel often ignores his duties, but his sister **doesn't**.
  5. Sanda likes to buy presents, but I **don't**.
  6. Kate and Ann don't like to do their rooms, but I **do**.
  7. What comes after winter?
    - Spring **does**.
  8. Who goes to school every day?
    - All the pupils **do**.
    - Nick **does**.

**1** *Identify the verbs in the sentences from the box above that are substituted by do/does.*

**2** *Make up your own sentences using do/does as the main verb substitute.*

## VII Writing

**1** *Write 5 sentences using do as a main verb substitute.*

**2** *Choose one of the stanzas of the poem that you like best, and translate it.*

**3** *Write a poem that you can dedicate to your mother for Mother's Day.*

**4** *Write a paragraph to explain all the things your mother does for you and your family.*



## I Let's Talk

- 1 Unscramble the lines of the poem below.
- 2 Read the poem and express its main idea.
- 3 Think of a title for the poem.
- 4 Comment on the poem making reference to pictures 1 and 2.



If you in the morning  
You can't pick them up  
In the course of the day.  
Throw minutes away,

You may hurry and scurry<sup>1</sup>,  
You've lost them forever,  
And flurry<sup>2</sup> and worry,  
Forever and aye<sup>3</sup>.

*Anna Sewell*

<sup>1</sup> scurry ['skʌrɪ] v. – a alerga

<sup>2</sup> flurry ['flʌrɪ] v. – a se grabi

<sup>3</sup> aye [aɪ] adv. – da

## 5 Debate on the following:

- We shouldn't have schools at all.
- It's not necessary to study English.
- Our school is perfect.
- Students agree to all the school rules and teachers' requirements.
- Handicapped people don't need any education.
- Films cannot help pupils learn English.
- Mothers have little importance in our lives.



## 6 Work as a class to match the words to their definitions.

- |                         |  |
|-------------------------|--|
| 1. head-master/mistress | a) a short film of actual events in the world              |
| 2. compulsory           | b) a full-length cinema film with an invented story        |
| 3. skill                | c) gentle and caring                                       |
| 4. to achieve           | d) to obey   |
| 5. aim/goal/purpose     | e) person in charge/principal of a school                  |
| 6. feature film         | f) ability   |
| 7. newsreel             | g) obligatory or mandatory                                 |
| 8. to mind              | h) to accomplish   |
| 9. tender               | i) something that an action or plan is intended to achieve |

## II Grammar

### 1 Paraphrase the sentences using the verb **wish**.

- |   |   |
|---|---|
| a) It's a pity Pete can't write poems.<br>Mother <b>wishes</b> Pete ...               | e) I'm sorry, I will not travel this summer.<br>I <b>wish</b> I ...               |
| b) What a pity I don't practise English.<br>I <b>wish</b> I ...                       | f) Mother is sorry her daughter doesn't like arts.<br>Mother <b>wishes</b> ...    |
| c) It's a pity not all parents understand their children.<br>Children <b>wish</b> ... | g) Teachers regret students don't read much nowadays.<br>Teachers <b>wish</b> ... |
| d) It's a pity he makes mistakes in spelling.<br>Our teacher <b>wishes</b> ...        |   |

### 2 Think of words with figurative meanings which have alternatives in your native language.

### 3 Give homophones for the following words:

*lessen (v), sew (v), waist (n), straight (adj), brake (n), hear (v), buy (v), wear (v), four (num), I (pron), two (num), won (v), their (pron).*

### 4 Identify the verbs in the sentences that are substituted by **do/does**.

- Mother often cooks breakfast for us, but my brother Mike rarely *does*.
- Some of my friends complain about school, but I *don't*.
- My father loves films, and so *do* I.
- Sally didn't eat her lunch, and we *didn't* either.
- They enjoy going to English Club, but Robert *doesn't*.

### 5 a) Observe the meanings of the phrasal verb given below:

- |                                 |   |
|---------------------------------|---|
| to look <b>at</b> —————         | to direct eyes at                                 |
| to look <b>for</b> —————        | to try to find something                          |
| to look <b>after</b> —————      | to take care of somebody who is ill, little, etc. |
| to look <b>forward to</b> ————— | to anticipate (with pleasure)                     |
| to look up to —————             | to respect and admire smb.                        |

### b) Insert the above phrasal verbs.

- The members of our English Club look ... .. the guests' arrival.
- When preparing for the club's meeting, the members have to look ... .. different necessary materials on the given topic.
- He looked ... .. the papers to find the club's working programme.
- Students are to look ... .. the equipment in their English Room.
- "Look ... .. the map of the USA!", said the teacher of Geography.



**I Pronunciation**

*Read as quickly as you can:*

A pretty schoolmistress from Daise  
 Had a list of the pupils to praise,  
 But it was very funny  
 'cause she lost all her money  
 And she couldn't give them any praise.



*"In creating, the only hard thing is to begin."*

*James Russell Lowell*

**II Conversational Formulas**

*Exchange opinions. In what circumstances will you use the following phrases?*



- You are doing very well.
- That is really beautiful.
- I wish I could do as well.



- First class!
- Great!
- Don't worry, I'm sure you'll do better.

**III Discussion Points****1 Answer the questions:**

- a) Why are artisanship articles highly appreciated all over the world?
- b) What qualities are necessary for artisans? (e.g. attention to details...)
- c) Which of these qualities are developed at schools?

**2 Explain the proverb "Art is long, life is short".****3 Say how you understand the lesson quotation.****IV Vocabulary****1 Read and pronounce the words and phrases.**

*Use a dictionary to find their meaning.*

|              |                         |         |              |           |         |
|--------------|-------------------------|---------|--------------|-----------|---------|
| <b>Nouns</b> | artisanship             | craft   | craftsman    | appliqué  | crochet |
|              | knitting needles        | hook    | tapestry     | canvas    |         |
| <b>Verbs</b> | to carve                | to knit | to embroider | to sculpt |         |
|              | to weave – wove – woven |         |              |           |         |

**2 Match the words with their definitions:**

- |   |   |
|---|---|
| <ol style="list-style-type: none"> <li>1. crochet</li> <li>2. tapestry</li> <li>3. knitting needles</li> <li>4. appliqué</li> <li>5. canvas</li> <li>6. to embroider</li> </ol> | <ol style="list-style-type: none"> <li>a) to decorate cloth with ornamental needlework</li> <li>b) needlework done with a needle having a small hook at one end</li> <li>c) any fabric used as a foundation for embroidering and painting</li> <li>d) a fabric consisting of a warp<sup>1</sup> upon which coloured threads are woven by hand</li> <li>e) thin plastic or metal rods which one uses when knitting</li> <li>f) something ornamented by a different material or a piece of the same type</li> </ol> |
|---|---|

<sup>1</sup> a warp [wɔ:p] n. – urzeala

**3** *Fill in the words: knit, sculpting, carving, woodcarving, crochet hook, artisans, embroider, tapestry, macramé, crafts, embroidery, knitting.*

- It seems there is no difference between ... and ... , but still they differ.
- The ... .. is in the box near the TV set.
- People who have to do with ... , ... , ... , ... , ... and other ... are called ... .
- In the evenings my granny prefers to sit near the fireplace and ... or ... .



**4** *Look at the artisanship articles in the pictures and say:*

- which of them you like best;
- if you have similar things at home;
- what articles you can make;
- which of the articles you make at your school;
- which articles you would like to have in your house or flat;
- if you know what other artisanship articles your great-great-grandmothers made in the past. If no, ask your Mums to help you.



**V** **Reading**

**1** *Look at the headline below and say what you think the text is going to be about.*

**2** *Read through the text quickly to see if you are right.*

**LEARNING THROUGH ART**

Children's creative work has always been appreciated. School is the fundamental place where pupils develop skills in different artisanship domains.

Manual work is widely practised by people from an early age. Pupils learn to create art at Handicraft lessons. The teachers train them how to use various instruments such as crochet hooks, knitting needles, carving knives, needles, etc. These magic tools bring children lots of ideas when working with them. Making flower compositions and different appliqués is taught at Design lessons.

At Drawing lessons pupils learn to work with brushes, water colours and oil paints. At Photography

Club children learn to take pictures. Traditionally, every school holds creative work exhibitions at which pupils display their pieces of art, such as tapestries, drawings, paintings, different flower compositions, seed and other appliqués, sculptures, carvings and photos etc. These exhibitions help schools underline learning through art.

When guests see the variety of articles made by children they are surprised at their great skills. These articles attract the eye because they represent real wonders.

The best pieces of work are sent to the city/town exhibitions of children's creative works where lots of visitors come and admire them.

**3** *Find in the text the words that mean:*

- |             |              |                |             |              |
|-------------|--------------|----------------|-------------|--------------|
| custom –    | to exhibit – | miracle –      | tool –      | exposition – |
| to praise – | to study –   | to emphasize – | diversity – | kids –       |

**4** *Work in pairs. Ask each other questions to fit the answers:*

- Pupils learn to create things of art.
- Teachers train pupils to use various tools.
- At School Photography Club.
- Pupils display their pieces of art.
- Children's creative works attract the eye.

- 5 Find at least 5–6 words you could leave out of the first and fourth paragraphs not changing the general sense. Do it in pairs.
- 6 Imagine you are a professional radio reporter and you are in the radio studio. After an introduction you present your report.

News commentator:

This is radio Chişinău. This is children's programme.

Our reporter will share the information and impressions of a school artisanship exhibition.

## VI Grammar

**REMEMBER** when **do** and **make** are used.

a) We use **make** when we mean: **to prepare, to build, to construct.**

E. g. – Children **make** different articles at Handicraft lessons.  
– My elder brother made a seed appliqué for me as a present.

b) We use **do** when speaking about activities/work.

E. g. – What shall we **do** at Drawing lesson tomorrow?  
– What is she **doing**?

**There are certain expressions with do and make that you have to remember:**

### Make

- to make noise
- to make coffee, tea
- to make somebody happy, sad
- to make friends
- to make somebody do something
- to make a translation
- to make a mistake

### Do

- to do shopping
- to do homework
- to do one's best to do something
- to do well
- to do cleaning, washing
- to do a job
- to do a favour

### 1 Fill in do or make.

- a) Students were ... noise while arranging the exhibition.
- b) Granny asked me to ... some coffee for her.
- c) Most of the children ... the job correctly.
- d) She prefers to ... cakes herself.
- e) If you ... at least a mistake when knitting, everything will go wrong and you'll have to ... the work all over again.
- f) Boys like to ... different carved things.
- g) ... the ironing of all crocheted articles you have ....
- h) Mum asked me to ... my best to help my younger brother.

### Revision:

#### 1 Open the brackets paying attention to the form of the verb after if:

- a) If my mother had a crochet hook, she (to make) a table cloth.
- b) If I (to have) enough money, I (to buy) some artisanship articles.
- c) If we (to have) a Photography Club at our school, we would join it.
- d) If this painting (to be) brighter, my mother would buy it.
- e) If I (can) buy nice wool, I would knit a sweater or jumper for my son.

#### 2 Supposing you found a big piece of gold, say what you would do with it. Work in chain.

## VII Writing

### 1 Correct the mistakes.

- a) Will you make me a favour?
- b) You did three mistakes in the word "artisanship".
- c) You need a hook to embroider something.
- d) If I would have needles, I would knit a sweater.
- e) If I am an artisan, I would decorate my house myself.

### 2 Describe in writing, in 50 words, the last artisanship exhibition you had at your school.

### 3 Imagine you are a reporter interviewing the participants of a school artisanship exhibition that won rewards. Write down the questions you'd like to ask them.

**I Pronunciation**

**Read as quickly as you can:**

Does a doctor doctor a doctor according to the doctored doctor's doctrine of doctoring?  
Or does a doctor doctor a doctor according to his own doctoring doctrine?



*“When work is a pleasure, life is a joy!  
When work is a duty, life is slavery.”*

*Maxim Gorky*

**II Conversational Formulas**

**Which of the phrases below will you use when asking about someone's work?**



- What do you do?
- What's your profession?
- Where do you work?
- Do you like your job?



- I am a ... .
- I work as a ... .
- I work at a ... .
- I really enjoy my job.
- I am a professional.

**III Discussion Points**

- 1 **Say if a person can be successful with big things if he/she isn't successful with small ones. Why?**
- 2 **Brainstorm a list of jobs you know.**
- 3 **Say what the following jobs deal with: translator, interpreter, secretary, musician, artist/artiste, sculptor, architect, mechanic.**
- 4 **Say which of these qualities are important when choosing a person for a professional job:**  

|             |         |             |             |        |
|-------------|---------|-------------|-------------|--------|
| experienced | patient | boaster     | selfish     | lazy   |
| liar        | skilled | responsible | active      | honest |
| determined  | rude    | arrogant    | hardworking |        |
- 5 **Explain the saying “Never do things in halves” and the proverb “As you make your bed, so you must lie on it”**
- 6 **Comment on the lesson quotation.**

**IV Vocabulary**

- 1 **Read and pronounce the words and phrases. Use a dictionary to find their meaning.**

|                   |                                  |                               |                               |                                       |
|-------------------|----------------------------------|-------------------------------|-------------------------------|---------------------------------------|
| <b>Nouns</b>      | plumber<br>salesman              | clerk/office worker<br>lawyer | accountant<br>road sweeper    | application (for)<br>position/vacancy |
| <b>Verbs</b>      | to cure                          | to engage                     | to dismiss                    | to deal with                          |
| <b>Adjectives</b> | full-time<br>skilled/experienced | part-time<br>(un) employed    | hard-working/industrious      |                                       |
|                   | to sow – sowed – sown (sowed)    |                               | to sew – sewed – sewn (sewed) |                                       |

**2** In pairs, match the words with their definitions:

- |                      |   |
|----------------------|---|
| 1. to sow            | a) to plant the seeds in the garden                             |
| 2. to dismiss (from) | b) a formal written request for a job                           |
| 3. to employ         | c) to get rid of somebody, to fire from a job                   |
| 4. application       | d) to hire or engage a person for a job                         |
| 5. advertisement     | e) to make somebody well again                                  |
| 6. to cure           | f) a public announcement that tells about an event or a product |

**3** In groups, fill in the gaps: *part-time accountant, mechanics, translator, managing director, interpreters, office clerks, unemployed, deal with, accountant, plumber.*

- |   |   |
|---|---|
| a) My uncle Steve got a new job as a ... a few weeks ago.   | c) ... usually ... documents.   |
| b) The advertisements in the city newspapers announced some vacant positions: a ... of a newly built hotel; an ... in the department store; two experienced ... in the Toyota car service Agency. | d) The private sector in Moldova gives opportunity to lots of ... people to get new jobs. |
|   | e) A newly opened Travel Agency is in need of a ... , a ... and two ... .                 |

**V** Reading

**1** Read the text and say if Andrew found a new job.

**A NEW JOB**

So Andrew had to leave Blaenely in a month. He began immediately to look for another position. He read all the advertisements in the newspapers and sent many applications to doctors who wanted an assistant,



but by the end of the second week, he had received no answer to his applications. Andrew really began to worry.

Three weeks passed and he almost lost hope to find a job. In the evening of the 30<sup>th</sup> of August he met Denny in the street.

"I'm rather sorry you are going, Manson," he said. "I want to tell you something. I heard this afternoon that the ABERALAW Medical Society is looking for a new assistant. It is thirty miles from here. Why don't you try?"

"Well, yes," Andrew agreed slowly. "I may try."

A few minutes later he walked home to write one more application.

On the sixth of September Andrew came to ABERALAW. The ABERALAW Medical Society was to select a new doctor out of seven candidates that had sent in their applications for this position. The selected doctor would have to work at a coal mine. All seven candidates had been asked to come.



Andrew was the third to enter the room of the Committee. About thirty miners filled the room. At a small table in the middle of the room he saw Owen, the secretary, and Llewelyn, the head doctor. Owen, in a quiet voice, explained the conditions of work there. Then the miners asked Andrew many questions about his work and himself, and then he left the room and the next candidate went in and then the next.

It was over at last. All the candidates were waiting. The door opened and Owen invited Manson again.

*(After A. Cronin)*

**2 Find in the text antonyms for the following words:**

|             |           |           |
|-------------|-----------|-----------|
| to come –   | morning – | old –     |
| to go out – | to send – | quickly – |
| to empty –  | answer –  | to lose – |
| to finish – | loud –    | there –   |

**3 Answer the questions:**

- |  |  |
|--|--|
| a) When and why did Andrew have to leave Blaenely?         | e) How many candidates took part in the competition for the vacant position in the Aberalaw Medical Society? |
| b) What did Andrew do as to find a new job?                | f) Who explained the conditions of work?   |
| c) What did Denny tell Andrew when they met in the street? | g) What did the miners ask Andrew?   |
| d) When did Andrew come to Aberalaw?                       | h) Why was he invited again?   |

**VI Grammar**

**Remember how to use:** **either** ['aɪðə/'iːðə]; **either ... or ...**; **neither** ['naɪðə/'niːðə]; **neither ... nor ...** .  
when meaning “one or the other” of the two people or things

- |   |  |
|---|--|
| a) Either of my two brothers-in-law can do this job.          | d) Neither of my cousins can get the vacancy, because they are not experienced enough. |
| b) My brother wants to become either a lawyer or an engineer. | e) Neither the position of an accountant nor of an office worker will suit my uncle.   |
| c) Either of the jobs is attractive.                          |  |

**1 Insert: either, either ... or ... , neither, neither ... nor ... .**

- |   |  |
|---|--|
| a) ... of you two will be engaged in our company.                       | e) ... experienced ... hardworking clerks will be dismissed.   |
| b) My sister likes ... embroidering ... knitting.                       | f) My aunt is looking ... for a part-time ... a full-time job. |
| c) When Nick was a child he wanted to be ... a policeman ... a fireman. | g) If you run after two hares, you will catch ... .            |
| d) ... of my grannies can fish.   |  |

**2 Use the grammar above in your own sentences.****VII Writing****1 Write how you think work will change in 50 years. What new jobs will appear and what jobs will disappear?****2 Write in 50 words the summary of the last two passages of the text.****VIII Additional Information***Do You Know that ...*

- when choosing candidates for any particular job, the Americans say, “What can this person do?”;
- the French say, “What qualifications has she/he got?”;
- the British say, “What kind of background has the person got?”



**I Pronunciation**

*Read as quickly as you can:*

Sporty sorts  
in sporty shorts  
play all sorts of sporty sports



“Sports do not build character. They reveal it.”

*Haywood Hale Broun*

**II Conversational Formulas**

*In what circumstances would you say?*



- Do you go in/out for sports?
- What’s your favourite sport?
- What sport do you go in/out for?



- My favourite sport is ...
- I enjoy ...
- I am really good at ...
- I am going in/out for ...

**III Discussion Points**

*Answer the questions:*

- a) What is your favourite sport as a spectator or a participant?
- b) What skills and training does it need?
- c) What do you think the main benefits of sports are?
- d) What distinguished national athletes do you know?
- e) What do you know about the last Olympic Games?
- f) How do you understand the lesson quote?



Olympic Games

**IV Vocabulary**

**1** *Read and pronounce the words and phrases. Use a dictionary to find their meaning.*

|                          |  |                              |                   |                 |  |
|--------------------------|--|------------------------------|-------------------|-----------------|--|
| <b>Nouns</b>             | weight-lifting<br>referee                | hockey stick<br>wrestling    | sprint<br>contest | puck<br>surfing | hang-gliding/water skiing<br>mountaineering/climbing |
| <b>Verbs and Phrases</b> | to score the victory<br>to end in a draw | to even<br>to serve the ball | to set records    |                 |  |
| <b>Adjectives</b>        | lasting                                  | required                     | decisive          |                 |  |

**2** *Match the words with their definitions. Do it in pairs.*

- |   |   |
|---|---|
| <ol style="list-style-type: none"> <li>1. to serve the ball</li> <li>2. to even</li> <li>3. contest</li> <li>4. wrestling</li> <li>5. event</li> <li>6. mountaineering</li> <li>7. referee</li> </ol> | <ol style="list-style-type: none"> <li>a) a sport in which two people wrestle and try to throw each other to the ground</li> <li>b) person who controls sports competitions</li> <li>c) a competition or a game in which people try to win</li> <li>d) activity of climbing mountains as a sport or hobby</li> <li>e) any of the races, competitions, etc., arranged as part of a day’s sports</li> <li>f) to make equal</li> <li>g) to throw the ball up and hit it to start play</li> </ol> |
|---|---|

**3 Fill in the words:** *scored, sprint, hang-gliding, scored the victory, ended in a draw, set records, weight lifting, hockey stick, puck, surfing.*

- a) ... .. has less supporters than football.
- b) You won't be able to play hockey without a ... .. and a ... .
- c) Their team ... .. in the competition.
- d) Champions in different sport events ... new ... every year.
- e) Soon after the game had started Mike ... the first goal.
- f) When we were at the sea side last year we used to go in for ... and ... .
- g) A 100 metres ... competition was held at our school last month.
- h) It was a keen competition and still the game ... ..

**4 Look at the pictures and say which of the sports you find:**

- boring
- expensive
- dangerous
- enjoyable
- exciting
- interesting
- difficult
- wide-spread
- attractive
- elegant
- romantic



**V Reading****1 Read the text and be ready to list which sports fit into different seasons.**

Sports has always played an important part in human history. Even in the distant past, people competed in different athletic events to train for the military, to represent their clans or their country, or simply to show their abilities. Why have sports been so important to human beings? Certainly, we can say that athletics is recreational and pleasurable. At the same time, it makes us healthy and strong. But, sports can also help us build relationships with different people. One goal of international sports events is to create peace between all people on Earth.

To achieve good results or set records at an athletic event, one should start going out for sports from early childhood. This makes muscles strong and perfects our skills. Most champions begin to run, jump and

play different games from a young age. There are so many sports to fit the interests of all kinds of people. Football, gymnastics, wrestling, boxing, chess, tennis, volleyball, basketball and swimming are only a few that we can list.

Different sports can also be played at different times of the year. Summer offers excellent opportunities for cycling, boating, canoeing, hiking, hang gliding and surfing. In winter, where there is a lot of snow, sports such as skiing, skating, tobogganing, hockey and bobsledding are very popular.

Whether you like team sports or individual athletics, there's something out there for you. Get involved, have fun and be a part of history; play sports.

**2 Answer the questions about the text:**

- When did people start to compete in different sport events and what for?
- Why should one start to go in for sports from early childhood?
- What main sports can you list?
- For what sports do the summer and the winter offer opportunities?
- Why should the young get involved in doing sports?

**3 Make up a plan to summarize the text.****VI Listening****1 Listen to the text. Write information about:**

- |   |                          |
|---|--------------------------|
| a) international sports                         | c) training requirements |
| b) when athletes are considered national heroes | d) sports in Moldova     |

**VII Grammar****Remember:**

The Subjunctive Mood in **that clauses** after the verbs expressing suggestions, orders, demands, requests etc...

| <b>See the Difference</b>   |   |
|---|---|
| <b>The Indicative Mood</b>  | <b>The Subjunctive Mood</b>   |
| <p>Our teacher of Physical Education <b>suggested going</b> in for different kinds of sports.</p> <p>The coach <b>insisted on observing</b> certain requirements.</p> | <p>Our teacher of Physical Education <b>suggested that we should go</b> in for different kinds of sports.</p> <p>The coach <b>insisted that</b> players <b>should observe</b> certain requirements.</p> |

The Sports Committee President **ordered** the coaches **to prepare** everything for the sports competitions.

The Sports Committee President **ordered that** the coaches **should prepare** everything for the sports competitions.

**Remember:**

In **that** clauses after the verbs **order, demand, insist, ask, require, request, suggest, propose, recommend, should** (for all persons) + **Infinitive without "to"** must be used.

Sometimes in newspapers and official documents the old form of the Subjunctive Mood (**without SHOULD**) is used after these verbs.

E.g. The National Sports Committee **suggested** that the results of the latest competitions **be** discussed.

**1 Work in pairs. Paraphrase the sentences below using *should* + Infinitive without "to":**

- The team's captain ordered the players to leave the play-ground.
- One of the sportsmen suggested resting at a resort on the Black Sea shore.
- "Let's arrange a crawling championship", proposed one of my classmates.
- Mike suggests running every day.
- "Iulian must be expelled from the team", demanded the coach.
- The coach ordered the players to be at the stadium at 6 a.m.
- "Schoolchildren must wear trainers at PE lessons", demanded the teacher.

**2 Work as a class. Open the brackets using the Subjunctive Mood.**

- The principal demanded that the pupils (not to be late) for PE lessons.
- One of the chess-players suggested that the contest (to hold) in Soroca.
- The referee recommended that the players (to play) correctly during the football match.
- Some official sports authorities suggested that Hagi (to coach) the national football team.
- The coaches always insist that the athletes (to meet) the strict requirements.

## VIII Writing

**1 Do Exercise 2 (V) in writing.**

**2 Form derivatives from the words given below using the suffixes *-ive, -tion, -ion, -ment, -able, -al, -ty*:**

|         |         |           |         |
|---------|---------|-----------|---------|
| compete | achieve | represent | require |
| nation  | educate | physic    | favour  |
| decide  | antique | honour    |         |

**3 Arrange the words to make up sentences.**

- players, of, scored, The, opponent, the, team, goals, four, won, so, they, the game.
- score, number, goals, of, When, in, match, a, say, we, the, teams, same, the, draw, it's, a.
- basketball, won, The, team, competition, they, been, trained, had, the, because, such, by, good, a, coach.
- countries, bring, Gifted, fame, sportsmen, and, honour, their, to.

**4 Write a paragraph in 50 words about the first Olympic Games.**

**I** Pronunciation

*Read as quickly as you can:*

If all good people were clever,  
And all clever people were good,  
The world would be nicer than ever ...  
*W. Wordsworth*

*“Charity begins  
at home”  
(proverb)*

**II** Conversational Formulas

*Which of the phrases below will you use in certain situations when consoling someone?*



- Don't get upset.
- Please, take it easy.
- Please, relax.
- It is not as bad as you think.



- Let me reassure you about...
- Don't worry, please!
- There's really no reason to ...

**III** Discussion Points

- 1 *As a class, discuss what charity means.*
- 2 *Speak about the charitable acts you know or you have taken part in.*
- 3 *Try to explain the difference between physical and mental handicap.*
- 4 *Say how you understand the lesson quote.*

**IV** Vocabulary

- 1 *Read and pronounce the words and phrases.  
Use a dictionary to find their meaning.*

|                   |   |                                     |                                |                                   |
|-------------------|---|-------------------------------------|--------------------------------|-----------------------------------|
| <b>Nouns</b>      | handicap<br>lack/shortage<br>deficiency | ability<br>disability<br>compassion | empathy<br>sympathy<br>charity | Braille (system)<br>crutch<br>dot |
| <b>Adjectives</b> | deaf<br>deprived                        | blind<br>severe                     | dumb                           |                                   |

- 2 *Work in pairs. Replace the underlined words in the sentences with one of the words below:  
disability, handicap, crutch, ability, compassion, severe.*

- a) In spite of her mental deficiencies, she manages to do a good job.
- b) You feel pity when looking at people with physical disabilities.
- c) After an accident he temporarily lost his walking capacity.
- d) My cousin broke his leg; so he used a support when walking.
- e) He has been suffering from a serious illness since his childhood.

**3 Match the words with their definitions:**

- |             |  |
|-------------|--|
| 1. deprived | a) someone who is completely unable to speak; mute                         |
| 2. shortage | b) someone who is unable to hear anything                                  |
| 3. lack     | c) someone who cannot see because his eyes are damaged                     |
| 4. charity  | d) a system of printing for blind people                                   |
| 5. empathy  | e) a very small round mark; point  |
| 6. dot      | f) the ability to share another person's feelings as if they were your own |
| 7. Braille  | g) kind and generous attitude  |
| 8. blind    | h) not enough or not at all  |
| 9. deaf     | i) not enough  |
| 10. dumb    | j) kept from having things   |

**4 In groups, share your knowledge on the Braille System and sign language.**

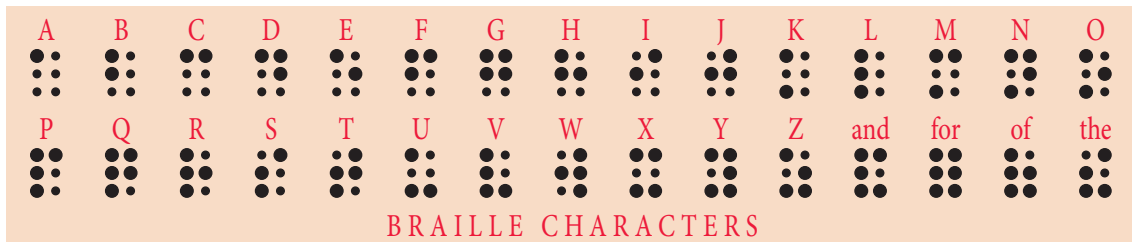

**V Reading**

**1 Read the text and try to answer the questions in the first paragraph.**

If I can stop one heart from breaking,  
 I shall not live in vain;  
 If I can ease one life from aching,  
 Or cool one pain ...  
 I shall not live in vain.

*Emily Dickenson (1830–1886)*

By nature, we are all born to live a happy life on earth and enjoy it. Unfortunately, there are children who can not enjoy life as you can. Have you ever thought that the possibility to walk, to see, to hear, to talk and to think is a real gift? Do you know that among your peers there are children who are not able to share all the above abilities? Perhaps you happened to see a mother holding a blind child by his hand or children walking on crutches. Did it touch your feelings? Did you meditate over it or pass by indifferently? We all must not be indifferent, and should have a special attitude towards handicapped children.

<sup>1</sup>peers [ˈpiəz] (n). – semeni



Each state provides equal rights for its citizens, and the right to education is one of them. Do you know that blind and deaf children and those with speech and mental deficiencies also go to school as you do? All schools for children with physical deficiencies arrange schooling according to the existing curriculum.

**2 Answer the questions:**

- Why shouldn't people be indifferent towards children with physical deficiencies?
- What rights does each state provide for its citizens?
- How is the existing curriculum fulfilled in schools for children with physical deficiencies?

**3 Comment on the epigraph of the text.****4 Think and give an appropriate title to the text. Brainstorm ideas. Choose the best one.****VI Listening****1 Listen to the text and answer the questions below:**

- What system are blind children taught?
- What is it like? How is it used?
- What language are deaf children taught?
- What is it made up of?
- Who attends auxiliary schools?
- What should our society do for children with physical deficiencies?

**VII Grammar****Remember:****HOMONYMS**

are words having the same spelling and sound but different meanings and origin.

**e. g.** well (adj/adv) (good, successfully)

*All is well with  
her family.*

well (n) hole, (oil) well; (v) to flow, to jet

*While digging the well (n) water  
suddenly welled (v) out.*

**HOMOPHONES**

are words having the same sound but different spelling and meaning understood from the context

**e. g.**

by – buy  
tale – tail

nose – knows  
meet – meat

**HOMOGRAPHS**

are words having the same spelling but different sound and meaning

**e. g.** (v) tear [tɛə] – (n) tear [tɪə]

**e. g.:** a) Mother saw tears on his face.  
b) Be careful not to tear your dress on that nail.

**1 Find in the text the homophones for the following words:**

*sea, no, bee, here, four, won, write, buy/bye.*

**2 Give the meanings of the following. Consult a dictionary.**

- homonyms: chest [tʃɛst]
- ring [rɪŋ]
- race [reɪs]

- homographs:

read < [ri:d] / [red]      close < [kləʊz] / [kləʊs]      desert < ['dezət] (n.) / [dɪ'zɜ:t] (v.)

**VIII Writing****1 Make up 6 sentences using homonyms, homophones and homographs.****2 Imagine you are rich and want to help physically and intellectually handicapped people. Write how you would do it.**

**I Pronunciation**

*Read as quickly as you can:*

Three grey geese  
In a green field grazing,  
Grey were the geese  
And green was the grazing.



*“Flowers are the sweetest things that God ever made, and forgot to put a soul into.”*

*Henry Ward Beecher*

**II Conversational Formulas**

*Say in which situations you will use the following phrases:*



- Can someone tell me ...?
- I wish I knew ...
- If only I knew ...
- I wish I knew more about ...



- I'd be very interested to know ...
- I wish someone would tell me about ...
- I'd like to know ...

**III Discussion Points**

**1** *As a class discuss about the major environmental problems in the world.*

**2** *Answer the questions:*

- a) What environmental campaign groups exist in our country? What are their names. What kind of activities are they involved in?
- b) Are you a member of such a group? Why? Why not?
- c) What do you think the best way to protect endangered species is? (Refer to both flora and fauna).

**3** *As a class, share ideas about the meaning of the lesson quotation.*

**IV Vocabulary**

**1** *Read and pronounce the words and phrases. Use a dictionary to find their meaning.*

|       |                             |           |             |         |
|-------|-----------------------------|-----------|-------------|---------|
| Nouns | poplar                      | acacia    | lark        | sparrow |
|       | maple                       | crocus    | woodpecker  | swan    |
|       | willow                      | swallow   | nightingale | quail   |
|       | linden (Br.E.)/lime (Am.E.) | blue tit  | eagle       |         |
| Verbs | to revive                   | to rustle | to wander   | to rim  |

**2** *Find in the box above the words that mean:*

- a) a small plant with yellow, white or purple flowers in spring.
- b) a tree that has long, narrow leaves.
- c) a small bird with blue head, wings and tail and a yellow breast.
- d) a small bird that sings especially at night.
- e) a large water bird with a long graceful neck.
- f) a tree with heart-shaped and sweet-smelling flowers.



**3** *Work in groups. Match the words with their definitions:*

- |   |   |
|---|---|
| <ol style="list-style-type: none"> <li>1. woodland</li> <li>2. bluebell</li> <li>3. crocus</li> <li>4. view</li> <li>5. to breed</li> <li>6. wildlife</li> <li>7. path</li> </ol> | <ol style="list-style-type: none"> <li>a) a plant with blue bell-shaped flowers</li> <li>b) wild animals and birds</li> <li>c) land covered with woods</li> <li>d) a small, white, yellow or purple flower grown in the gardens in the early spring</li> <li>e) a line of ground that people walk along</li> <li>f) a scenery, panorama</li> <li>g) to raise (animals)</li> </ol> |
|---|---|

**4** *Work in pairs to identify the names of the birds in the pictures below and give as much information as possible about them.*



**5** *Insert the missing words: willows, eagles, maple, wander, to revive, linden, larks, rustling, poplar, ash, nightingales, acacia, swallows, quail, woodpecker.*

- a) He used to ... in the hills last summer.  
 b) The government has to do the best ... the polluted environment.  
 c) A pleasant ... blossom smell could be distinguished at a distance.  
 d) When walking through the park they could hear the ... of the tree leaves.  
 e) Lots of people dislike the ... in blossom as it is very allergenic.  
 f) They say that the free areas in Moldova's *Codri* will be planted with ..., ... and ... trees.  
 g) The alleys in the park were lined with ... .  
 h) ... and ... are the first birds to come from the South in spring.  
 i) A great number of birds like owls, ..., ... are disappearing nowadays because of the polluted environment.  
 j) The ... is a wild little bird like a hen that is often seen in the steppes of Moldova.  
 k) The ..., with its long sharp beak, destroys lots of harmful insects, doesn't it?

**V** **Reading**

**1** *Scan the text and say why Crystal loved the ranch and its surroundings so much.*

The birds were already calling to each other in the early morning stillness<sup>1</sup> of the Alexander Valley, as the sun rose slowly over the hills. The leaves on the trees rustled gently in the breeze as Crystal, a girl of fifteen, stood still in the damp grass, watching the brilliant sky. For brief moments, the birds stopped singing. Almost as though they, too, were in awe<sup>2</sup> of the valley's beauty. There were grassy fields, surrounded by hills where their cattle wandered, grazing. Crystal loved the ranch not for what it brought them, but for what it was. Every inch<sup>3</sup> of her soul loved the ranch, and this valley. She had inherited her father's passion

<sup>1</sup> stillness ['stɪlnɪs] n. – tihnă

<sup>2</sup> awe [ɔ:] n. – admirație

<sup>3</sup> inch [ɪntʃ] n. – țol, inci(e) 2,54 cm

<sup>4</sup> beneath [bi'ni:θ] adv. – mai jos

for the land, for the rich brown earth, and the thick green grass that carpeted the hills in the spring-time. Now she seemed to commune silently with spirits only she knew were there. She watched the tall grass rustle softly in the breeze and felt the warmth of the sun shine down on her wheat-coloured hair. And she began to sing softly. Then she suddenly began to run, pressing the damp grass beneath<sup>4</sup> her feet. She headed toward the river. She sat on a smooth gray rock, feeling the icy water dance over her feet as she watched the sunlight reach the rocks. She loved watching the sun rise, loved running in the fields; she loved just being there. She knew there was no one to watch her standing gracefully in the stream.

*(After Danielle Steel)*

**2** *Work independently. Find in the text antonyms for the following words:*

|           |         |            |           |           |
|-----------|---------|------------|-----------|-----------|
| late –    | long –  | ugliness – | to hate – | stopped – |
| quickly – | noise – | cold –     | poor –    | under –   |

**3** *Find in the text lines that describe:*

- the morning stillness;
- Crystal's love for her father's ranch;
- Crystal's love for the picturesque landscape surrounding her.

**4** *In pairs, ask questions on the text.*

- 5 Read the text again and suggest possible title variants. As a class choose the best one.
- 6 Summarize the text; be detailed when describing nature.
- 7 Say if you happened to admire the beauty of nature in a similar way. When? Where? How was it?

## VI Grammar

Remember:

### EXCLAMATIONS

#### COMPARE

What a nice bird! (**countable**) or How nice the bird is!  
**but:** What dull weather! (**uncountable**) or How dull  
 the weather is!

What nice birds! (**countable**) or How nice the birds are!  
 What news! (**uncountable**) or How interesting the  
 news is!

- 1 Fill in with **a, an, or -**.
 

|                                |                                   |                                      |
|--------------------------------|-----------------------------------|--------------------------------------|
| a) What ... deep valley!       | f) What ... nice parrots!         | k) What ... rich flora and fauna!    |
| b) What ... picturesque hills! | g) What ... fresh air!            | l) What ... attractive surroundings! |
| c) What ... brilliant sky!     | h) What ... tall trees!           | m) What ... poor vegetation!         |
| d) What ... grassy field!      | i) What ... graceful swan!        | n) What ... beautiful nature!        |
| e) What ... smooth rock!       | j) What ... polluted environment! | o) What ... ugly animal!             |
- 2 Change the sentences above using "How"

## VII Writing

- 1 Do ex. 1 (VI) in writing.
- 2 Fill in the missing prepositions.

... early spring days, when nature is awakening  
 ... its winter sleep, I prefer going ... different parks ...  
 my city. First I walk ... a while, then I usually sit ... a  
 bench and admire the trees which start getting green.  
 I happen to see different species ... birds sitting high up

... the trees singing their songs. The squirrels, climbing  
 up and down the trees or jumping ... branch ... branch,  
 arouse my admiration. It's a pleasure to admire nature,  
 it's a relaxation afterwards. It is here, ... the park, that I  
 meet my old friends and make new ones.

- 3 Continue the story below.

It happened in the second half of July when my  
 father, my elder brother and I decided to go to the woods  
 and gather mushrooms there. It was a hot summer day.  
 On reaching the woods, we sat in the shade under a big  
 oak tree. It was a marvellous place from which we could

admire the picturesque landscape surrounding us.  
 What pleasure it was to enjoy the blue tits' and black-  
 birds' singing! What a symphony of birds' calling to  
 each other you could hear in the quiet woods!

But soon...

## VIII Additional Information

### Believe It or Not

- The woodcock is the only bird that can sing without using its throat. It sings by vibrating its feathers.
- The wolf, a symbol of ferocity, is the most affectionate parent in the animal world.

**I Pronunciation**

*Read as quickly as you can:*

- a) The three thirty train to Tooting tootled through the tunnel.
- b) Summer's season slowly stretches, Susan Slocum she.  
So she signed some simple sketches –  
Soul sought soul successfully.



*“The world is a book. Do those who do not travel read only a page?”*

*St. Augustine*

**II Conversational Formulas**

*Use the phrases below in microdialogues when verifying the information:*



- Do you like travelling?
- Where are you going this summer?
- How long are you going to ... ?
- Have a good trip!



- Yes, very much.
- I like travelling by ...
- We'll go to ...
- We are going by ...
- Thanks a lot.

**III Discussion Points**

- 1 *Working in a chain, answer the question: Why do people travel?*
- 2 *In pairs, speak about advantages and disadvantages of travelling by different means of transport.*
- 3 *As a class, speak about the countries you have visited.*
- 4 *Say if any incidents happened to you while travelling. If yes, tell about them. (Say who, where, how, when, what...).*
- 5 *In groups, plan a trip.*
- 6 *Comment on the lesson quote.*

**IV Vocabulary**

- 1 *Read and pronounce the words and phrases. Use a dictionary to find their meaning.*



|                   |             |                     |                        |
|-------------------|-------------|---------------------|------------------------|
| Nouns             | carriage    | compartment car     | single/one way ticket  |
|                   | air hostess | inquiry office      | return ticket          |
| Verbs and Phrases | porthole    | left-luggage office |                        |
|                   | porter      | berth               |                        |
|                   | to board    | to deliver          | to fasten safety-belts |
|                   | to depart   | to check in/out     |                        |
|                   | to miss     | to see off          |                        |

- 2 *Match the words with their definition. Do it in pairs.*

- |   |  |
|---|--|
| <ul style="list-style-type: none"> <li>1. to board (a train)</li> <li>2. compartment car</li> <li>3. carriage</li> <li>4. to depart</li> <li>5. to check in</li> <li>6. to check out</li> </ul> | <ul style="list-style-type: none"> <li>a) to get on</li> <li>b) to pay the bill and leave the hotel one has been living in</li> <li>c) to leave</li> <li>d) one of the separate sections of a train that carries passengers</li> <li>e) one of the separate sections of a carriage</li> <li>f) a bed in a boat, train, or a caravan</li> </ul> |
|---|--|

7. porter  
8. berth

- g) a person whose job is to carry things, luggage  
h) to fill in the necessary forms before staying at a hotel or to show one's ticket before going on a flight

**3** *Fill in the missing words: left-luggage office, porthole, to catch, air hostess, missed, see off, safety belts, single, to fasten.*

- a) During his flight Ionuț could admire but silver clouds through the ...  
b) "If you want ... the 6 o'clock train you'll have to get up early in the morning," said mother.  
c) Although he got up rather early he ... the train.  
d) The tourists left their suit-cases in the ... and went to make a tour round the city.  
e) The ... asked the passengers ... their ...  
f) The passengers asked the inquiry officer if they could book ... tickets.  
g) My father went to ... our friends from London.

**4** *Work in pairs. Add suffixes or prefixes to the words on the topic, suggested by your deskmate to form new parts of speech.*

**V** *Reading and Speaking*

**1** *Read the text.*

**AN UNFORGETTABLE TRIP**



The Drăgans decided to travel to the Carpathian mountains. Radu, the Drăgans' younger son, was excited to hear the news. No words could express his enthusiasm. This time, travelling by train was chosen so as to have the opportunity to admire the picturesque landscapes of the country. Some days prior to the journey, father booked return tickets for a tourist train.

The family arrived at the railway station just before departure. People were in a hurry. Some fuss<sup>1</sup> could

<sup>1</sup> fuss [fʌs] n. – forfotă, agitație

be observed there. Radu's friend also came to see the travellers off. A porter helped the Drăgans carry the luggage into the compartment. Soon they all got on the train and occupied their comfortable seats. Radu chose the upper berth. The train started on time.

The tourists were in their highest spirits. The train left Chișinău and headed towards Ungheni. The trip itself was exciting from the very beginning. Soon the tourists took pleasure in watching the orchards and vineyards stretching over the countryside hills. The family couldn't help admiring the Cornești region hills covered with green grass and woods, easily distinguishing high oak, linden, elm and ash trees. Farther on, the sunflower and corn fields extending northward; the green plains and meadows, with cattle grazing, remained to the south-west. The journey wasn't tiring at all.

It took the travellers almost a whole day to reach Piatra Neamț, a small town situated at the foot of the Carpathians. The beauty of this town and its surroundings can be compared to that of a pearl. Naturally, this beauty couldn't but fascinate the travelling family.

**2 Work in pairs. Find in the text words that mean:**

|             |           |                     |             |
|-------------|-----------|---------------------|-------------|
| chance –    | to lead – | before –            | to get to – |
| to enjoy –  | cuisine – | leaving (n) –       | journey –   |
| to notice – | area –    | to buy in advance – |             |

**3 Work independently. Find in the text lines about:**

- |                                      |                                 |
|--------------------------------------|---------------------------------|
| a) the family choice for travelling; | e) the pleasure the family had; |
| b) the departure;                    | f) the Cornești region;         |
| c) the weather;                      | g) the fields and animals;      |
| d) the route they headed;            |                                 |

**4 Work in groups. Ask questions on the text.****5 Summarize each of the paragraphs.****VI Listening****1 Listen to the second part of the text and correct the statements:**

- |  |   |
|--|---|
| a) the train started to Bacău                  | c) the next day the train left Brașov                     |
| b) nothing but sea was in the travellers' view | d) every day Radu got to the top of the very steep mount. |

**2 Listen to the text again and say how you understand the phrases:**

- |                                    |                                     |
|------------------------------------|-------------------------------------|
| a) ... <b>and, what was worse;</b> | b) ... , <b>which annoyed ... .</b> |
|------------------------------------|-------------------------------------|

**3 Prove that the family's stay in Brașov was enjoyable.****VII Grammar****Remember:**

The difference in the meaning of the adverb "**naturally**" which depends on its place in the sentences:

The boy imitated the bird's trilling so **naturally** that I couldn't notice any difference in sound.

**Naturally**, all those who travel usually have exciting adventures.

**1 Make up dialogues using the word naturally in both meanings.****2 Insert the phrase ... and, what was worse, or ... which annoyed ... .**

- Victor lost his way in the woods ... , ... .. it was getting dark.
- The thought ... .. mother was the long over sea trip she had to take.
- Annie was in a hurry to the railway station ... , ... .. there was no taxi to catch.
- Sandu's mountaineering, ... .. father, was not only useless but dangerous as well.

**VIII Writing****1 Describe in writing your last journey mentioning:**

- |                                 |  |
|---------------------------------|--|
| a) when it happened;            | d) the people you went with;           |
| b) where you travelled to;      | e) the places you visited;             |
| c) means of transport you used; | f) your impressions about the journey. |

**2 Write, in dialogue form, a conversation in which three friends argue about how they should travel to a distant place, each of them suggesting different means of transport.**

## I Let's Talk

- 1 **Work with the text given below:**  
 a) *In pairs, arrange the fragments in logical order.*  
 b) *Paraphrase one of the passages at the teacher's choice*



*Requiem Dragoste*

### “SCULPTURE IS MY DESTINY”

The sculptor finds his inspiration in different historical events and in personal feelings and then expresses it in stone sculptures. We can firmly state he has brought history to art. This is a talent given to Iurie Canașin by God, a talent to do something for other people.

Iurie Canașin is a well-known sculptor in Moldova. He has created a lot of remarkable monuments in Chișinău. Among them is “Requiem Dragoste” that is dedicated to famous, and dear to us all, Doina and Ion Aldea-Teodorovici who died tragically in 1992.

It is not easy to be a plastic artist and really create wonderful monuments. It means you have to live for your people, for their destiny, and sculpt it in history.

When at the University, he thought of becoming an artist, but then made a self-discovery which showed him a real way to art, his art for life.

He became a sculptor who lives and creates for people. In all his works one can read the message, “Living among people created by the same Divine Hand, the main subject I’m passionate for is Jesus Christ – the son of God; who came to save and make us more generous.”



*Iu. Canașin and E. Doga*

- 2 **Give the names of the chess pieces given below in your native language.**

- 1 knight
- 2 castle or rook
- 3 queen
- 4 bishop
- 5 king
- 6 pawn



- 3 **Brainstorm ways of solving disabled people's problems.**
- 4 **Tell your Artisan Club visitors what you do, how you make different things and what you use when working.**
- 5 **Say and comment if it is a pleasure to hear:**
- a) the leaves rustling in the trees;
  - b) the birds singing;
  - c) the rain beating on the roof of your house after long dry weather;
  - d) the waves rolling on to the shore of a sea;
  - e) the buzz of the bees flying from flower to flower.
- 6 **Explain the proverb "He, that travels far, knows much".**

## II Grammar

- 1 **Put the verbs in the brackets in their correct tense form.**
- a) If the weather (to be) nice tomorrow, we'll go for a walk.
  - b) When we came into the woods, the birds of different species (to sing).
  - c) Before Nick (to go) to the stadium, he (to do) his homework.
  - d) My friend said he (to visit) the most beautiful places in Valea Oltului.
  - e) Alice asked Nick if the school Artisan Exhibition (to hold) every year.
  - f) My cousin wondered if I (to go) to the Eminescu Theatre the next day.
  - g) The PE teacher said our sportsmen (to set) new records at the previous competitions.
  - h) The announcer said the sports reportings (to broadcast) two days later.
  - i) Some Environment Ministry workers mentioned that fauna and flora of Moldova (to be) in a deplorable state.
  - j) If you (to visit) our English Classroom you would observe lots of interesting and useful things in it.
  - k) While Victor (to run), his friend Nellu (to play) tennis.
  - l) When I (to enter) the English Classroom I saw a lot of sophisticated equipment in it.
- 2 **Open the brackets using the Subjunctive Mood after the verbs: suggest, demand, propose, recommend, insist.**
- a) The teacher of Nature Studies suggested that we (to help) people keep our parks, lakes, rivers and woods clean.
  - b) My friend Sorin proposed that we (to feed) the starving birds in cold winter season.
  - c) The government demands that the landowners (to introduce) less herbicides and pesticides into the soil.
  - d) Mother recommended that the family (to go) for a picnic in the woods on the bank of the Nistru river in Vadul-lui-Vodă.
  - e) The city authorities demanded that drivers (to look after) their cars and not pollute the air.
  - f) The forester insisted that the campers (to leave) the picnic place clean.
- 3 **Change the sentences to express unreal condition.**
- Example:** If I am healthier, I'll go in for different sports.  
 – If I **were** healthier, I **would go** in for different sports.
- a) If Andrew has talent, he will create pieces of art.
  - b) What will people do, if flora and fauna are endangered?
  - c) Will your father get upset if he is dismissed?
  - d) What will happen to our environment if people don't protect it?
  - e) Will you be able to talk to the deaf if you learn the sign language?
  - f) If you are not very busy, will you travel to the USA?



# End-of-Book ROUND UP

## CHECK YOUR KNOWLEDGE

### I Let's Talk

#### Who is the Winner?

Work in groups

- 1 Look at the picture and name all parts of the body you know.



- 2 Name all kinds of footwear/clothes and their colours.
- 3 Name various professions you know.
- 4 Imagine you have to lay an Easter holiday table. Name the things you need.
  - dishes
  - food
  - drinks
- 5 Make up a network on the topic **Family**.

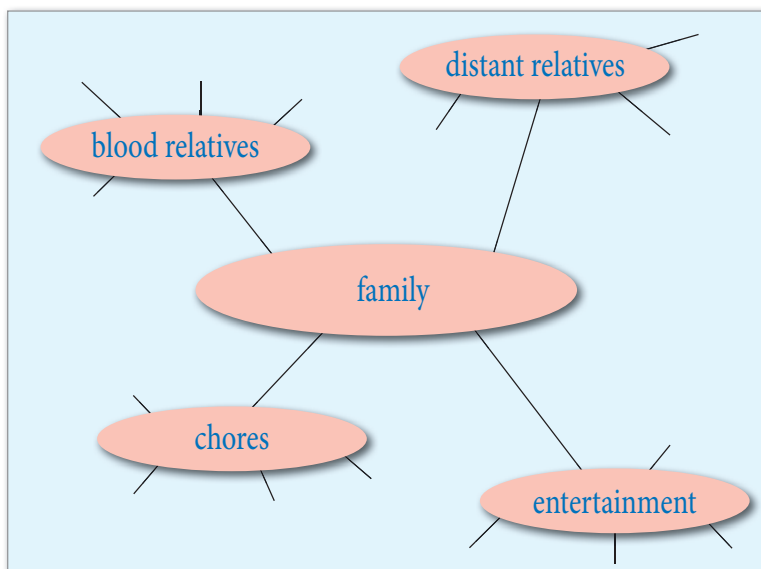

## CHECK YOUR KNOWLEDGE

**Great Britain****6 Name:**

- the highest mountain;
- the most important river and seaport;
- the largest cities;
- the population;
- holidays and traditions;
- the most famous lakes;
- the most famous universities;
- the places of interest in London;
- what waters wash the country.

**7 Comment on the pictures below:****8 Brainstorm a list of seaport cities in the world.****9 Think of either a famous person, or someone you know personally who has overcome difficulties and made a success of their lives. Say how he/she has done it and what he/she has achieved.****10 Speak about two traditions in our country that visitors from abroad could enjoy.****11 Comment on the quotation "A friend to all is a friend to none". Do you agree or disagree with it? Why/why not?****8 Name different types of houses people live in.****9 Say what made American films most popular with the audience.****10 Name all famous cinema stars you know.****11 Rhyme four lines dedicated to:**

- a) your mother;
- b) your school.

**12 Name:**

- a) historical figures of our country;
- b) famous sportsmen of our country and from abroad;
- c) birds and trees;
- d) places of interest in Chişinău.

## CHECK YOUR KNOWLEDGE

**II Grammar****1 Choose the right verb form:**

- a) My trousers are/is too tight.  
 b) My jeans are/is old and holed.  
 c) Those glasses is/are his.  
 d) Scales is/are used for weighing things.  
 e) The police is/are coming.  
 f) Where (are/is) the money?

**2 Use active or passive voice in the sentences below:**

- a) Children usually (to visit) museums, churches, and theatres at weekends.  
 b) Corina's new friend (to invite) also to the party.  
 c) Who (to drive) the car?  
 d) Which English book (to translate) now?  
 e) John, why are you walking? – You see, my car (to repair).  
 f) His shoes (to repair) tomorrow.

**3 Report the sentences:**

- a) Granny said, "Don't forget about grandpa's birthday."  
 b) Lorry said, "Mum cooked tasty pies yesterday."  
 c) Vlad said, "Why didn't you come to my birthday party last Sunday, Lena?"  
 d) Marius said, "What were you celebrating when I came in?"  
 e) Marcus said, "Where will you celebrate your Golden Jubilee?"  
 f) Anna said "I am sure we will have a nice time at the party tomorrow."  
 g) Sanda said, "I will be receiving guests at this time tomorrow."  
 h) Denis said, "My father was born in 1980."  
 i) Andy said, "I have bought a nice present for my parents."  
 j) Grandpa said, "Let's begin the party."  
 i) Alex said, "Don't eat spicy food, Olimpia."  
 m) Sandu said, "John had studied our traditions before coming to Moldova."  
 n) Sorin said, "We are decorating the house at the moment."  
 o) Inga said, "My parents prefer to celebrate their birthdays at home."

**4 The sentences below contain present simple tense verbs.**

**Define the kind of action they express: general truth or repeated action.**

- a) After the ceremony the bride throws back her veil.  
 b) The following Sunday after Good Friday is Easter.  
 c) Lamb is an Easter favourite food in many countries.  
 d) "What is there in my stocking, I wonder?" every child thinks on Christmas night.

**5 Ask questions to the underlined words.**

- a) New Year's Day usually marks the start of a new year.  
 b) Mother's Day is an important holiday in our family.  
 c) It was very nice to be present at our grandparents' golden wedding anniversary.  
 e) On Easter Sunday people go to church to bless Easter cakes and eggs.  
 f) On Halloween children dress as ghosts and witches.  
 g) My friend's sister got married last Sunday.

**6 Report the following:**

- a) Greg said, "Let's have some chocolates."  
 b) Alina said, "Andrew, don't forget to buy a cake for Nadya's birthday."  
 c) Cristina said, "Have some more juice, Sandu."  
 d) Dad said, "Don't drink cold water, Gabi."  
 e) Mum said, "Nastea, put the pie into the oven, please."

## CHECK YOUR KNOWLEDGE

**7** *Change into Indirect Speech:*

- a) Meg said, "Mr. Lourence watches us like a motherly old hen."  
 b) Mum said, "Does Hanna treat Meg with respect?"  
 c) She said, "Did you give my dearest love to your mum?"  
 d) He said, "My nephew graduated from Bălți University."  
 e) She said, "I think my mum will be proud of her daughter."  
 f) Dad said, "Why didn't you help your little sister yesterday?"  
 g) Granny said, "I will not tell our secret to anyone."  
 h) Ann said, "My little brother looks sober when mum is out."  
 i) Paul said, "My parents don't scold me when I make mistakes."

**8** *Report the following sentences:*

- a) She said, "Has your mum bought you a new hat?"  
 b) They said, "We haven't learned to sew buttons yet."  
 c) He said, "I have met him before the meeting."  
 d) Silvia said, "I had tried the new blouse on before I bought it."  
 e) She said, "Why has your sister changed her job?"  
 f) Pete said, "The secretary had not typed the announcement on time."  
 g) John said, "Our firm has not engaged a new lawyer yet."  
 h) The students said, "Had you equipped the classroom before the school year started?"

**9** *Work in pairs. Report the following:*

- a) Pete said, "I am doing my homework now."  
 b) The teacher said, "Is he coming to school today?"  
 c) She said, "Will you be travelling at this moment on Sunday?"  
 d) Tom said, "Mum, I am not telling lies."  
 e) He said, "What were you doing at 9<sup>00</sup> last night?"  
 f) She said, "When I come home my sister will be playing a new game."  
 g) He said, "What music were you listening to when I came in?"  
 h) Father said, "I won't be having a rest when you come home, Bob."  
 i) My sister said, "Why was your new friend acting that way?"  
 j) The boys said, "We are not quarrelling, we are discussing a new project."

**10** *Open the brackets using Present Perfect Progressive or Past Perfect Progressive.*

- a) The mechanic (to install) the new equipment in our laboratory for the last ten days.  
 b) When the supervisor came to the construction site, the builders (to work) for half an hour.  
 c) When I came home my sister (to sleep) for two hours.  
 d) Adrian says they (to furnish) the house for five days.  
 e) Diana wants to know for how long her friend (to read) the book.

**11** *Paraphrase the sentences using the verb "wish" and "if".*

**Example:** It's a pity I can't go to the cinema tonight.

I wish I could go to the cinema tonight.

If I could go to the cinema tonight, I would enjoy the new film.

- a) It's a pity I can't go to the cinema tonight.  
 b) It's a pity I am not a cinema star.  
 c) What a pity I don't know Spanish.  
 d) I am sorry I can't practise English every day.  
 e) She is sorry she won't have a party tomorrow.

## SCRIPTS

## Unit I

## LESSON 4

## MR. ROCHESTER'S VISITORS

It was a mild, quiet spring day – one of those at the end of March and beginning of April. The guests were expected to arrive on Thursday afternoon. All work had been completed the previous evening.

Thursday afternoon arrived; Mrs. Fairfax put on her best black satin dress, her gloves, and her gold watch, for it was her duty to receive the company, to conduct the ladies to their rooms and halls.

A joyous noise was heard in the hall. There were only eight people; yet somehow, as they entered, they gave the impression of a much larger number. Some of them were very tall; many were dressed in white.

First, there was Mrs. Eshton and two of her daughters. She had evidently been a handsome woman, and still looked good. Of her daughters, the eldest, Amy, was rather little, naive, and childlike in face and manner, wearing a white thin cotton dress. The second, Louisa, was taller and more elegant in figure, with a very pretty face. Both sisters were fair as lilies.

Lady Lynn was a large, stout woman of about 40. She was very straight and richly dressed in a satin dress. Her dark hair shone brightly.

Mrs. Colonel Dent was less showy, but, I thought, more lady-like. She had a slight figure, a pale, gentle face, and fair hair.

But, the three most distinguished – partly, perhaps because they were the tallest figures of the company – were the Dowager Lady Ingram and her daughters Blanche and Mary. Lady Ingram was between 40 and 50. Her figure was still fine; her hair (by candlelight at least) still black; her teeth, too, were still perfect. Most people would have said she was a splendid woman of her age. She had a fierce and a hard eye. She swallowed her words while speaking, and her voice was deep.

Blanche and Mary were of equal stature: straight and tall as poplars. Mary was too slim for her height, but Blanche was moulded like a Diana.

## LESSON 5

Mrs. Ciobanu: Good morning!

Shop Assistant: Hello. How can I help you?

Mrs. Ciobanu: I need to get a new pair of shoes.

Shop Assistant: Certainly. What kind of shoes would you prefer, madam?

Mrs. Ciobanu: I'm looking for a pair of low-heeled walking shoes for work. I have rather small feet.

Shop Assistant: I see. Here is a pair that should be your size. Try them on.

Mrs. Ciobanu: These are a little tight. Could you show me another pair, a size bigger?

Shop Assistant: Here you are. Will these do?

Mrs. Ciobanu: This pair is much better. I'll take them. How much are they?

Shop Assistant: Come this way, and I'll get that information for you.

## Unit II

## LESSON 1

## THE MYSTERIOUS CASE OF THE GINGER TWINS

When the twins Tim and Tom were born, their mother and father and grandparents were really very happy, but they were also a little puzzled. You see, Tim and Tom were born into a dark-haired Irish family. Their parents both had coal black hair. Their grandparents also used to have heads of thick black hair. Now, their grandparents' hair was turning silver. In fact, all the uncles, aunts and cousins in the family had very dark thick black hair. In Ireland, people with black hair and dark eyes are called "black Irish," and this is often a sign of beauty.

Their relatives, who visited them in the hospital, immediately thought that Tim and Tom were just cute as a button. But, everyone was at a loss as to why they had full heads of bright red hair. Though there is no lack of redheads, or "gingers," in Ireland, no one could

<sup>1</sup> leprechaun [ˈlɛprəˈkɔːn] n. – spiriduş, în folclorul irlandez

think of a family member with red hair. It was clear that the twins had their father's distinctive chin and nose. Also, from their first viewing, all the relatives commented on how the boys had their mother's eyes and dimples. But, they also joked that the twins had been kissed by a leprechaun<sup>1</sup>, and that was the reason for their bright red hair.

After seeing the boys, their great uncle Bill went home to look through old photos. There, he discovered a picture of a distant relative: the sister of the twins' great grandmother, Aunt Lizzie. Her picture was in black and white, but it was clear that her hair was lighter than her sister's.

No one can tell for sure if great, great Aunt Lizzie was a ginger, but the family was happy to say that the mystery was solved.

## LESSON 2

So, there we were in the church; everyone gathered for the big event – the wedding of my older brother Chuck and his soon-to-be wife Karen. I had a perfect view of the entire event because I was standing up in front in a fancy suit as one of the groomsmen. The church was really hot, and I could see several of the other guys sweating. The women were fanning themselves and trying to stay cool.

I couldn't believe how many family members showed up for this event. Both of our grandmothers were there; Dad's two sisters, Mom's two brothers, all of their kids, a bunch of cousins from Mom's side of the family, and even my great aunt Phyllis (who had never married, but always seemed to be at family weddings) were all present.

Of course my two sisters, Barbara and Samantha, were there. Barbara's husband, my brother-in-law Clark, who is in the military and just returned from overseas, was really sleepy and his eyes kept closing while his head fell, and that would sort of wake him

up. Then he would doze off again. Samantha, who is younger than me, kept pointing at him and giggling.

Except for the heat, everything was going very well. The priest was talking too long about love and family, and that's when it happened! I saw Uncle Phillip, who was the Best Man, begin to collapse as his knees bent. But, instead of falling forward, he fell to the side, and all the other groomsmen, except me, fell over like bowling pins. My new sister-in-law, Karen screamed, threw her hands up, and let go of the bridal bouquet which flew through the air and hit Aunt Phyllis right in the face. Aunt Phyllis fell backwards with her hands in the air and slapped Clark right in his face, waking him up suddenly. He must have been dreaming about the military, because he jumped up and shouted, "They're coming boys! This is it!" The entire church, filled with relatives and friends, started laughing.

Everyone wants their wedding day to be memorable, and that was a day that we would never forget: the wedding that ended with a war.

## LESSON 3

## AT THE BUCURIA CONFECTIONERY

- Shop Assistant:** Can I help you?
- Customer:** Yes, please. I'm having a party tonight. What can you offer for dessert?
- Shop Assistant:** That's my pleasure. There's a great variety: cookies, various cakes, chocolates, sweets, toffees<sup>1</sup>, wafers<sup>2</sup> and muffins<sup>3</sup>.
- Customer:** That's great. Then I'd like a chocolate cake. By the way, how much is it?
- Shop Assistant:** It's 134 lei. Anything else?
- Customer:** Yes, sure. How much are those chocolates?
- Shop Assistant:** Sorry. Do you mean *Moldova*? They are 90 lei.
- Customer:** Fine, two boxes, please.
- Shop Assistant:** Is that all?
- Customer:** Of course, not. We are a lot tonight. 1 kg of wafers and some kinds of toffees, be so kind. How much is that?
- Shop Assistant:** Just a minute, please. 134 and 90 plus 50 lei, toffees and wafers ... 274 lei please.
- Customer:** Here you are! Thank you, good bye.

<sup>1</sup> toffee ['tɒfi] n. – caramelă<sup>2</sup> wafer ['weɪfə] n. – gofră, vafă<sup>3</sup> muffin ['mʌfɪn] n. – briș

## Unit III

## LESSON 1

**Part 1 – Scotland**

Scotland has both highlands and lowlands. The highlands are among the oldest mountains in the world. The highest mountain in Scotland is Ben Nevis (1,347 meters high). There are a lot of valleys and lakes in this region, and the best known lake is Loch Ness. The main rivers in Scotland are the Clyde and the Tay in the west, and the Forth and the Tweed in the east.

The capital of Scotland is Edinburgh, and it is the cultural centre of the country. But, the biggest city in Scotland is Glasgow. It's an industrial city and an important port in the UK.

**Part 2 – Wales**

Wales is a highland country of old, hard rocks. North Wales has mountains and deep valleys. South Wales is a land of high hills. Welsh and English are both official languages in Wales. The population of Wales is over 3 million people. About 66% of the people of Wales live in urban districts. The capital of Wales is Cardiff.

**Part 3 – Northern Ireland**

Northern Ireland occupies one sixth of the territory of the UK. The population of Northern Ireland is 1.81 million people, and its capital is Belfast. Although English is the most common language in Northern Ireland, the government recognizes two minor languages as well: Irish and Ulster Scots.

**Part 4 – Government of the UK**

The UK is a constitutional monarchy. The official head of the State is the King or Queen, but the power of the monarch is limited by Parliament which is made up of the House of Lords and the House of Commons. The members of the House of Commons are elected. The British people elect 650 members of the House of Commons every five years. The members of the House of Lords are not elected; they are appointed. These members are permanent, and are often aristocrats, people of the church, lawyers and former politicians. The head of the Government is the Prime Minister, who is the leader of the party in power.

## LESSON 2

## HORATIO NELSON

Nelson was a skilful and fearless commander enjoying great love and devotion from the men who served under him. They respected Nelson so much that they were ready to die for him. He used to take calculated risks and never failed.

H. Nelson fought for England for the last time in 1805, as Commander-in-Chief of the British naval forces confronting France and Spain at Cape Trafalgar (capul Trafalgar/мыс Трафальгар), the most south-westerly point of Spain. Under Nelson's indication, the well known sign: "England expects that every man ought to do his duty" was put up on

<sup>1</sup> deck [dek] n. – punte

the flagship. Nelson, standing on the deck<sup>1</sup> of the ship, at a moment, a musket ball (glonte de flintă/мушкетная пуля), fired from a French ship, struck him and pierced one of his lungs. He was mortally wounded and died a few hours later. Before he died he realized his naval forces had won a great victory. And that brought him fame.

In his memory, a tall column with Nelson's statue on its top stands in Trafalgar Square in London.

Nelson was buried in the Crypt of St. Paul's Cathedral.

## LESSON 3

## SINGAPORE

Singapore is an island city-state off the southern tip of the MALAY PENINSULA, 137 km north of equator. It consists of 63 islands with total land area of 704 km<sup>2</sup>. The first records of settlement in Singapore are from the 2nd century AD. Singapore is a name of both the city and country that constitutes a single municipality.

Singapore became a British colony on August 2, 1824. By 1869, 100.000 people lived on the island. At present, Singapore has a diverse population of 5 million people made up of the Chinese, Malays, Indians, Asians and Caucasians of different ethnic origins. Even before independence in 1965, Singapore was already one of the richest states in East Asia due to its strategic location as a port.

After independence, Singapore with the help of foreign direct investment created a modern economy focused on industry, education and urban planning. The country is also a highly cosmopolitan world city with a high percentage of foreigners that amount to 42%. Singapore maintains diplomatic relations with 175 countries.

**Climate.** Singapore has a tropical climate with no distinctive seasons, uniform temperature and pressure, high humidity, and abundant rainfall. About 23% of Singapore's land area consists of forest and nature reserves. Urbanization has eliminated many areas of former primary rainforest.

**Tourism in Singapore.** Singapore is a famous travel destination, making tourism one of its largest industries. To compete with regional rivals like Bangkok, Hong Kong, Tokyo and Shanghai, the government has announced that the city area would be transformed into a more exciting place by lighting up the civic and commercial buildings. Singapore's cuisine also attracts tourists. Medical tourism is promoted as well.

**Ports and aviation.** Singapore is a major international transportation hub in Asia, positioned on many seas and air trade routes. Today the port of Singapore continues to be among the top 5 busiest ports in the world. Singapore is also an aviation hub for the South-east Asian region and a transit between Australia and Europe. Singapore airport has a network of 81 airlines connecting Singapore to 185 cities in 58 countries.



## LESSON 4

A lot of families in Great Britain and the US live in flats, but still a great number of people live in detached houses. They are usually built out of brick and stone. As a matter of fact, British houses are not large, but comfortable. Americans like to live in large houses. Most British as well as American houses are two-storeyed. The houses are well-planned and cosy. As a rule, on the ground floor there is a sitting room, a dining room, a kitchen and a hall. The bedrooms and a bathroom are upstairs. English houses often have

two doors: a front door for guests and a back door. Traditionally the British have a fireplace, a symbol of warmth in the house where they like to sit by fire in winter evenings. In American houses there is a laundry room next to the kitchen – a place in the house where they wash and dry clothes. In addition to all these rooms, they usually have a recreation room and a work-out room in the basement. One cannot imagine a house in Britain and America without lawns at the back and a flowerbed in the front.

## Unit IV

## LESSON 1

**Billy:** Hey Caroline, I noticed that you are in my English class. How do you like it?

**Caroline:** It's okay. I like reading, but I don't like all the homework.

**Billy:** I know what you mean. Mrs. Kennedy can be a little sour. Well, maybe I could help you out. Do you want to study together?

**Caroline:** How would we study literature together?

**Billy:** I was thinking that we could each read a part of the book, each share our parts, and then write a report together.

**Caroline:** But we have to write separate reports. Besides, weren't you at the bottom of the class last semester?

**Billy:** Well, yes, but this would be a way for us to spend some time together.

**Caroline:** So, you really aren't interested in learning more, or getting better marks; you just want to spend time with me?

**Billy:** Uh. Well. Yes. I mean, no. I just kind of thought...

**Caroline:** That's sweet, but I think I'll do my own homework.

## LESSON 2

Steve, a pupil from England, is visiting a school in Chisinau. He meets Marin, a 7th form student, and they have a conversation.

**Marin:** Steve, it's great to meet you. I've always wanted to talk to a native English speaker who is my age. It's great to chat with you.

**Steve:** You know, even though Moldova isn't an English-speaking country, your English is really good.

**Marin:** Thanks. It's great to hear that.

**Steve:** I'm curious how you learned to speak English so well. Can you show me around? I'd like to know what helps you learn English.

**Marin:** Well, we can't ignore the fact that many of our schools have special classrooms just for learning English. You might have noticed that we are in an English classroom now.

- Steve:** Sure. I see all the grammar charts, the maps, and the vocabulary words on the walls. I also noticed the portraits of the great English and American writers such as William Shakespeare, Charles Dickens, Mark Twain, to name a few that I see. Over there, isn't that Earnest Hemingway?
- Marin:** You're right.
- Steve:** I see that you have a number of computers and other technological devices as well.
- Marin:** Yes, the teachers like to use modern equipment to make the classes more interesting. There are so many dialogues, short films, vocabulary and grammar lessons online. These make the teachers' lives easier, and the students really like learning from the Internet as well. I know I learn vocabulary much more quickly with the use of visual aids.
- Steve:** I have to say how impressed I am by your interest and enthusiasm. It's amazing to see these modern facilities to help you learn.
- Marin:** Well, I also want to say that all of this would be nothing without the devotion of our teachers. Our teacher is really the one who inspires our love of the English language.

## LESSON 3

## GRAMMAR IN RHYME

Three little words you often see,  
 Are Articles A, An and The.  
 A noun is the name of anything,  
 As School, or Garden, Hoop, or Swing.  
 Adjectives tell the kind of Noun,  
 As Great, Small, Pretty, White, or Brown.  
 Instead of Nouns the Pronouns stand,  
 Her head, His face, Your arm, My hand.  
 Verbs tell of something being done –  
 To Read, Count, Laugh, Sing, Jump, or Run.

How things are done the Adverbs tell,  
 As Slowly, Quickly, Ill, or Well.  
 Conjunctions join the words together –  
 As men And women, wind And weather.  
 The Preposition stands before  
 A noun, as In or Through a door.  
 The Interjection shows surprise,  
 As Oh! how pretty! Ah! how wise!  
 The whole are called nine parts of speech  
 Which reading, writing, speaking teach.

*Unknown*

## Unit V

## LESSON 3

In Great Britain, people are fond of rugby, cricket, golf, horse-racing, etc. Football in England, like in many countries is a preferred sport, and it has the largest number of fans. In the United States, team sports such as American football, baseball and basketball are very popular for both men and women. Every country has its favourite sports, and every year, participants in those sports get together to compete.

Gifted athletes bring honour and fame to their countries when they win gold, silver or bronze

medals at major international competitions such as the Olympics. These athletes are considered national heroes. This is a well-deserved title because of the difficulty and intensity of their training.

Depending on the kind of sport, hours and hours each week must be spent on specific exercises. Athletes must think about the balance between challenging themselves and pushing too hard. They have to choose how many exercises they will do each day. Based on their bodies, they must decide if they will work out at

the beginning or the end of the day. And, they must eat right and get plenty of sleep.

In Moldova, a kind of wrestling (trânta) and a type of baseball (oina) are national sports. Football is still the most popular. Our state government pays a lot of attention to young people, creating good facilities for them to play. Internal competitions and

championships are held in kickboxing, wrestling, volleyball, weightlifting, horsemanship, etc. The best athlete from these local competitions is then invited to compete at international events. Our country never misses the chance to send its sports representatives to the Olympic Games.

## LESSON 4

Blind children are taught the Braille system, where the letters are printed as groups of rising dots that blind people feel with their fingers. The deaf are taught sign language which has a special grammar. Sign language is made up of a limited number of elements: the shape of the hand, movement, location and orientation. For people born deaf, or who lost their hearing before they developed language, communication in sign language is a comfortable and necessary alternative to speech. There are also boarding schools providing adequate education for handicapped children; they live and study there. Part of the teaching staff in these schools are educators, and

they help these kids with everything after hours. There are also auxiliary schools for children with mental deficiencies. Here schooling is done according to a local specific curriculum. Along with schooling, training for appropriate occupation is performed.

Many state and voluntary organizations, and even ordinary people, help these schools to adapt socially and integrate disabled children, not depriving them of anything. It's important to understand what charity and compassion mean in our lives. Even you can do something for such children; for example, visiting such schools and making new friends there.

## LESSON 6

### AN UNFORGETTABLE TRAVEL

After a very short stop in Piatra Neamț, the train started again on the route to Brașov. Nothing but mountains were in the travellers' view. Unfortunately it was already evening; it began getting dark and the tourists' interest in admiring nature in the twilight lessened (s-a redus), though the mountains were incomparable. And, what was worse, Radu, by that time, felt tired and soon fell asleep. Early in the morning next day, the train arrived in Brașov and here the Drăgans' train trip finished. They stopped in a cabin at the foot of a high mountain and stayed there

for a week. What fun they had! Every day they used to go for long walks admiring fast running streams in narrow canyons and climbing some mountains from the tops of which beautiful panorama could be seen.

Radu enjoyed staying in the mountains very much. The only thing which annoyed him was his failure to climb up a very steep mount. He never got to its top. It was natural for Radu not to succeed as he was not a mountaineer and had no practice in climbing.

The time passed so quickly, and the Drăgans had to return home.

## BACK TO GRAMMAR

## TENSES

**1** *Open the brackets using the Past Simple, the Past Continuous and the Past Perfect:*

- a) My sister Anne (to buy) me a pair of brown shoes as a birthday present last Sunday.
- b) When mother (to come) home, Julian (to look) for his new trainers.
- c) After my cousin (to break) his left leg on the skating-rink, he was taken to the hospital.
- d) Before Mike (to go) to the mountains, he (to have) a serious disease.
- e) Julian said he (to visit) all the footwear stores in the town.
- f) Last Friday my class (to have) a meeting at which we (to talk) about hygiene at school and at home.

**2** *Use the appropriate form of the verb to be:*

- a) The flock of sheep I had seen from the bus (was, were) moving towards the village.
- b) The poultry (is, are) kept in a chicken-pen<sup>1</sup>.
- c) Sheep (is, are) valued for wool and mutton.
- d) There (was, were) cattle grazing on the pasture.

<sup>1</sup> pen [pen] n. – a small fenced area for keeping animals

**3** *Open the brackets using the Past Simple or the Present Perfect.*

1. We (not to see) ... each other for a very long time.
2. We last (to go) ... to the theatre two years ago.
3. My friend (to start) ... learning English when he was eight.
4. My friend (to look) ... so miserable yesterday, so I had to raise his spirits.
5. Steve (to look) ... so unhappy when I saw him.
6. When ... you (to make) friends with her?
7. I got to know him ten years ago and I never (to be sorry) ... for this.
8. My new friend (to stop) ... doing competitive sport.
9. I never (to see) ... my friend look this happy.
10. You ... ever (to quarrel) with your friend?

**4** *Put the verbs from the brackets in the Present Perfect or the Present Perfect Continuous.*

1. How long Mike (to live) ... in this house?
2. I (to paint) ... the room since morning but I (to do) ... only half of it.
3. We already (to furnish) ... all the rooms.
4. Why are your hands dirty? – Oh, I (to wash) ... the windows since 9 o'clock.
5. You know, the Smiths (to move) ... to a new house.
6. Our family always (to live) ... in this very house.
7. The plumber (to install) ... the central heating all these days.
8. They already (to hang) ... all the pictures in the sitting-room.
9. My mum (to buy) ... plants for each room this week.
10. They (to build) ... a garage next to their house recently.

**5 Choose the correct variant from the brackets:**

My uncle ... (was, has been, had been) the owner of a green-house for the past 5 years. He ... (was, is growing, grows) cucumbers and tomatoes in it. Last year he ... (gathered, was gathered, has gathered) a good crop. After he ... (sold, has sold, had sold) the vegetables at the market, his profit ... (went, is gone, has gone) up

sharply. He decided to enlarge the area, and said he ... (will increase, would increase, will be increased) the harvest and would get richer. When he started this business nobody (believes, had believed, believed) in his success. Now there is no doubt his business (had become, has become, became) very profitable.

**6 Open the brackets putting the same verb into 10 different Tenses.**

1. I (to study)... English when I go to University.
2. I (to study)... English when my friend came.
3. I (to study)... already six English tenses.
4. I (to study)... some new grammar rules by January.
5. I (to study)... English twice a week.
6. I (to study)... English for three months.

7. I (to study)... English when I was at the kindergarten.
8. I (to study)... English at the moment.
9. I (to study)... English for about a year when I got the invitation to the USA.
10. I (to study)... English at this moment tomorrow

**7 Open the brackets.**

1. When (to be) ... it the last time when your parents planned a family adventure?
2. She never (to disappoint) ... her parents.
3. When I came home my mother already (to read) ... my first article in the magazine.
4. Respect and love should always (to persist) ... in a real family.
5. Why you (not to tell) ... the truth to your mum?

6. While we (to discuss) ... the plans for our vacation my younger brother (to come) ... with a new idea.
7. Communication (to help) ... us overcome family problems.
8. My grandparents (to marry) ... for almost 40 years.
9. The children (to prepare) ... the surprise before their parents came home.
10. Our family (to move) ... into a new flat recently.

**8 Use the right form of the verbs in the brackets.**

1. She (to decide) to enter a college after the gymnasium.
2. They (to learn) a lot about the vocational school before they entered it.
3. The dressmaker (to take) measurements for my new dress.
4. She (to have) this up-to-date sewing machine for some years.
5. He (to work) as a tailor for a long time.
6. Students (to study) a lot of interesting things at vocational schools.

7. They (to have) a party at this time next week.
8. People (to pay) much attention to fashion nowadays?
9. When I (meet) him in the shop yesterday he (to buy) new equipment for his work shop.
10. When the student (to come) in, the teacher had already begun his lecture.

**9** *Open the brackets. Use the Present Perfect Progressive or the Past Perfect Progressive.*

1. My brother and I (to clean) ... the living room since 2 o'clock.
2. We already (to clean) ... our room for an hour when mum came home.
3. When I visited them she said, they (to build) ... their house for a year.
4. They (to build) ... their house all this summer.
5. How long your brother (to work) ... as an engineer?
6. He (to work) ... about the house for an hour when somebody knocked at the door.
7. Why are your hands in paint? – I (to paint) ... the floor.

**10** *Open the brackets using the Past Simple, the Past Perfect or the Past Perfect Progressive.*

I (just/finish) ... writing a letter when the door bell (ring) ... I (go) ... immediately to answer it because a neighbour of mine (tell) ... me he was going to call round. When I (open) ... the door, I (see) ... that there was no one there although I was sure I (hear) ... the bell. After I (look) ... up and down the street for a few minutes, I (shut) ... the door again and (begin) ... to wonder if I (dream) ... I (decide) ... finally that I (mistake) ... a car horn for the sound of the door bell. Just as I was turning round, I (notice) ... something white on the door mat. I (examine) ... it more closely and (realize) ... that someone (push) ... a note under my door. As I (never/see) ... the handwriting before, I (begin) ... to feel a little alarmed.

## ACTIVE AND PASSIVE VOICE

**1** *Use the right tense and voice of the verbs in brackets.*

1. In 1834 the Houses of Parliament with the exception of Westminster Hall (to destroy) ... by fire.
2. The Monument to Washington (to visit) ... by hundreds of people every day.
3. You ever (to swim) ... in the Mediterranean Sea?
4. When I came home my sister already (to return) ... from a safari in Africa.
5. She (to climb up) ... Mount Kilimanjaro three times already.
6. Our teacher (to tell) ... us about her excursion in Australia when the door opened and a new student (to come) ... in.
7. What places of interest you (to see) ... in Ireland?
8. When you (to go) ... to the mountains?

**2** *Change into Passive. Mind the prepositions.*

1. Why did you turn off the video?
2. We have put away all our unnecessary things.
3. I'm sure they will turn our advice down.
4. Look! She is putting on her new uniform.
5. She hasn't turned back the books to the library yet.
6. They turned up the music and everybody could dance.
7. The president of our club put off our party because he had to go abroad.
8. She took her words back, she admitted she was wrong.
9. They will turn the sound down when their parents come.
10. She never puts her things away accurately.

**3** *Open the brackets using the Present Simple, the Present Progressive, the Past Simple and the Present Perfect both in Active and Passive Voice:*

- |   |   |
|---|---|
| 1. Who (to build) this house now?                               | 5. Tasty food (to cook) now.  |
| 2. This house (to build) by skilful workers now.                | 6. Silvia and John (to marry) last year.                            |
| 3. Some people (to build) their houses themselves.              | 7. Pete and Radu never (to know) each other before.                 |
| 4. My house (to build) in a place not far from the bus station. | 8. The ceremony usually (to take) place every day at the same time. |

**4** *Change the following sentences into Passive Voice.*

- |  |  |
|--|--|
| 1. The students greeted the famous lecturer warmly.          | 6. Mum presented me with a book about professions.   |
| 2. They are writing a composition about their future career. | 7. Our uncle is designing a new hotel at the moment. |
| 3. Ann will invite all her friends to the party.             | 8. The staff is discussing his project.              |
| 4. Are they employing him at the moment?                     | 9. Why did you choose this job?                      |
| 5. He will write a new book next year.                       | 10. Is he looking for a new position?                |

**5** *Use Passive Voice.*

- |  |  |
|--|--|
| 1. Usually the brides (to dress) ... in white.                           | 6. A farewell party (to organize) ... before leaving for London next week. |
| 2. My sister (to give) ... a lot of flowers on her birthday last Sunday. | 7. The dessert already (to prepare) ...                                    |
| 3. In Indonesia alcohol (not to drink) ... at weddings as a rule.        | 8. The ceremony (to held) ... at the Grand Hall tonight.                   |
| 4. A big turkey (to cook) ... at the moment.                             | 9. ... you (not to invite) ... to the party yet?                           |
| 5. When the guests arrived the table already (to lay) ...                | 10. Look! What a wonderful engagement ring (to offer) ... to her.          |

**6** *Open the brackets using the Present Simple, the Past Simple, the Present Perfect, the Present Perfect Progressive, the Past Continuous, and the Past Perfect Progressive using the right tense and voice.*

- |   |  |
|---|--|
| 1. They just (to finish) discussing the advantages of this project.               | 7. When Cornel came home, his father and a helper (to furnish) the flat for 5 hours.                       |
| 2. Father (to weed) the corn field since early morning.                           | 8. Our government (to prepare) a very serious project regarding the solving of the environmental problems. |
| 3. Victor said his family (to live) in the country for 15 years.                  | 9. Radu said that the President (to elect) every four years.   |
| 4. When the foreign guests arrived in Chişinău the new airport (to open) already. |  |
| 5. When they arrived in Chişinău it (to rain).                                    |  |
| 6. My friend wants to know if I (to visit) the USA.                               |  |

**7 Use the right tense and voice, choosing the right word from the box.**

1. Bad ... (not to make) people happy.
2. All the ... (to spend) yesterday.
3. The ... (to pack) tomorrow.
4. ... (to be) a nice sport
5. The ... (to find) under the bed.
6. ... (to use) to cut paper and other things.
7. His new ... (to fit) him perfectly.
8. The ... he brought (to be) of great help to us.
9. Her ... (to be) of no use to us.
10. The ... (to call) as soon as the accident happened.



**8 Use the verbs in the correct tense form (Active or Passive).**

Twelve ravens (to keep)... in the Tower of London for centuries. They used to come in from Essex for food when the Tower (to use)... as a palace. Over the years people (to think)... that if the ravens ever left the Tower, the monarchy (to fall)... . So Charles II (to decree)... that the ravens should always (to keep)... in

the Tower and a salary should (to pay)... for taking care of them. Sometimes they (to live)... as long as 25 years. Their wings (to cut)... so that they couldn't fly away, and when a raven (to die)... another raven (to bring)... from Essex.

**9 Use the right tense and voice of the verbs in brackets.**

1. In 1666 80% of London (to destroy) ... by Great Fire of London.
2. A lot of houses (to build) in Chisinau every year.
3. I never (to eat) such delicious fruit.
4. Before I (to leave) the house, I (to call) Bob.
5. You ever (to be) to Greece?
6. While mother (to cook), father (to vacuum) the flat.
7. This summer our students (to visit) many European countries.
8. She (to paint) the room for two hours.

**10 Use the right tense and voice of the verbs given in brackets.**

1. My dad (be) ... very much a country man; he (to bring up) ... in a village.
2. People who (to live) ... in small villages (to have) ... close ties with their neighbours.
3. My grandparents never (to keep) ... a horse.
4. When we (to arrive) ... at my grandparents, my uncle (to prune) ... the trees in the garden.
5. Butter, cheese, sour-cream and yoghurt (to make) ... from cow milk.
6. Hens, ducks, geese and other birds (to breed) ... both for their eggs and meat.
7. A farmer (to own) ... an area of land consisting of fields and buildings, where crops (to grow) ... and animals (to keep) ... .
8. Listen! The birds (to sing) ... in the trees.
9. My uncle said he (to plant) ... apple-trees in his garden.
10. If the weather (to be) ... good the crops (to be) ... nice.



## R E P O R T E D S P E E C H

### 1 *Report the following sentences.*

1. She said, "When was it the first time you met your friend?"
2. She said, "How long has it been since you got a new friend?"
3. He said, "I can trust my friend totally."
4. She said, "Mary always supports me when I am in need."
5. He said, "I shall go out on a picnic with my friends."
6. She said, "My mum has always been the most important friend in my life."
7. Mum said, "A friend is like a plant of slow growth."
8. Father said, "What has happened to your friend?"
9. She said, "Who do you go to when you have problems?"
10. He said, "They are having a debating on friendship now."

### 2 *Here are a few things your mother reportedly said yesterday. Find out what her real words were and make all the necessary changes while writing.*

1. Mum said she didn't like those pickles, because they were too sour.
2. She promised to cook triangular dumplings for supper.
3. She added she would be happy if I helped her to prepare the cow cheese and sour cherry filling.
4. She was sure there was some sour cream in the fridge.
5. She wanted to know where the sour cream from the fridge was.
6. She asked my brother to go to the shop to buy sour cream, butter and eggs.
7. She told him to bring the purchases as soon as possible.
8. She suggested calling dad and ask him to buy some ice-cream.
9. She asked me to lay the table and light a candle.
10. She assured us that she was pleased to cook for us, the dearest.

### 3 *Report the following.*

1. She said, "Why didn't you come to support our team?"
2. He said, "Last week we had an interesting talk with our coach".
3. The coach said, "I'm sure our team is the best and we will win".
4. She said, "What winter sports can you name?"
5. She said, "Football was invented in Great Britain".
6. He said, "I have never gone in for horse riding".
7. She said, "Mountaineering is an exciting but a dangerous sport".
8. He said, "You should go in for sports if you want to keep fit".
9. He said, "It's a pity the competition had begun before I arrived".
10. She said, "Don't disturb him, he is training at the moment".

**4 Report the following sentences.**

1. The teacher said, "Don't waste time, start your work immediately".
2. She said, "I have been reading this book for 3 days".
3. He says, "It's very useful to have grammar drills more often".
4. My sister said, "We watched an interesting science fiction film at school yesterday".
5. He said, "When I came home my elder brother was reading an article about people's caring attitude toward disabled people".
6. She said, "Why didn't you join us while visiting the children in the orphanage?"
7. The headmaster said, "The Educational Department has provided our school with all necessary equipment".
8. He said, "What will you do after finishing the gymnasium stage?"
9. He said, "The teacher is speaking about the children's rights now".
10. She said, "Are the children deprived of any rights in your country?"

**5 Report the following.**

1. "Don't be late, otherwise you'll miss the film" – the teacher said.
2. She said, "This actor has played different roles in different films".
3. He said, "I never watch black- and-white films".
4. She said, "Are black-and-white films produced nowadays?"
5. Mum said, "Don't worry. We will go to the cinema next week".
6. He said, "I have watched this film twice already".
7. He said, "Emil Loteanu had made a lot of films in Moldova before he moved to Moscow".
8. She said, "The children are enjoying their time watching a cartoon at the moment".
9. She said, "This cinema was opened last year".
10. "The audience applauded the actors with great enthusiasm," my brother said.

**6 Report the following.**

1. The teacher said, "America was discovered by Columbus".
2. She said, "Abraham Lincoln became the 16<sup>th</sup> President of the USA in 1861".
3. He said, "Have you been to America?"
4. He said, "The USA borders on Canada".
5. "The official language in the USA is English", she said.
6. My friend said, "The Library of Congress is the largest national library in the world".
7. She said, "I enjoyed travelling through the USA".
8. She said, "There are 50 stars on the USA flag".
9. She said, "George Washington was born in Virginia, just south of Washington, D.C.".
10. He said, "Being in the USA I made a lot of friends".

**7 Report the sentences.**

1. The teacher said, "John, why are you always late?"
2. The boy said, "Dad, I promise to be a good boy and get only good marks."
3. Mum said, "Ann, what were you doing when I called you?"
4. Dan said, "When I was going to school, I met my cousin Andrew".
5. Tom said, "These are the most interesting places I have ever seen"
6. The teacher said, "If you haven't visited London yet, you should do it".
7. Inna said, "Could you pass me the sugar, please?"
8. Sandu said, "While I was doing my home task, my sister was playing computer games."

## M O O D D I S T I N G U I S H I N G

### 1 *Conditional I. Write the correct forms of the verbs from the brackets.*

1. Her sister (not to go) ... to England if she (not to pass) the exams.
2. If parents (to want) ... their children to read, they (to take) ... them to the library and help select books.
3. Your brother (not to help) ... you if you (to get) ... into trouble?
4. A child (to be) ... patient, if he (not to live) ... in a tolerant family?
5. If a child (to live) ... with friendship and acceptance, he (to find) ... love in the world.
6. If parents (not to teach) ... their children values and ideals, how their children (to find) ... meaning and purpose in their lives?
7. Children (not to learn to give) ... and absorb the joys and sorrows of a family life if their parents (not teach) ... them what sacrifice is.
8. A child (not to do well) ... in life if he (to do) ... poorly in school.

### 2 *Open the brackets.*

1. I wish I (can) ... knit like my mother or teacher.
2. If my mother (to teach)... me knitting, I (to be) ... very proud.
3. He wishes his sister (to buy) ... a knitting machine.
4. If he (to have) ... skills in moulding, he (to take) ... part in the competition.
5. If she (to embroider) ... the blouse in light colours, it (to look) ... nicer.
6. I (to learn) ... many nice things if I (to join)... our artisanship club.
7. Our teacher wishes she (to take) ... us to that famous Exhibition of Fine Arts.
8. If I (to be)... more skilled, I (to crochet) ... a pullover for my younger brother.
9. What you (to do)... if your pieces of art (to accept) ... for the exhibition?
10. My grandmother wishes our young generation (to know) ... more about weaving process.

### 3 *Paraphrase the sentences using the Subjunctive Mood after wish:*

1. It's a pity the wounded bird can not fly.
2. What a pity I cannot help save the world.
3. It's a pity we can't take care of all the starving animals and birds.
4. It's a pity he doesn't know much about this bird.
5. What a pity she can't hear the birds singing.
6. It's a pity our River Bîc is polluted.
7. It's a pity I don't live in the countryside, I would take care of birds and animals.
8. What a pity the birds can't speak.
9. It's a pity we don't have enough knowledge about wildlife.
10. What a pity the people throw litter in the streets.

### 4 *Put the verbs from brackets in their correct form in the given clauses of time and condition:*

1. If my sister-in-law (to write) me when she is arriving, I'll prepare a bedroom for her on time.
2. When students (to graduate) from the University, they (to start) to train for their professions.
3. As soon as I (to become) a mechanic, I (to repair) all my car accessories.
4. I (to go) to her first-night performance in case she (to invite) me.

**5 Translate into your native language.**

1. As soon as father comes home, I will make him a surprise.
2. She will not talk to you until you apologize to her.
3. He won't help his friend unless he asks him.
4. After she does her room, she will join us.
5. My grandfather says he will work as long as he lives.
6. When school is over children will go hiking.
7. She will use this information in case she needs it.
8. If the weather permits, we will go swimming.
9. If the Browns had enough money they would buy a new house.
10. It's a pity my friend doesn't speak foreign languages. I wish he did.
11. Our teacher suggests that students pay more attention to their pronunciation.
12. The director insists that employees be punctual.
13. I wish I were in Australia now.
14. Nick wishes he were travelling round the world now.
15. I wish I could write poems.

**6 Open the brackets using the Subjunctive Mood after *if*.**

1. If father (to teach) me some handicrafts skills, I (to help) him in making different artisanship articles.
2. Nick would begin sports trainings if he (to buy) new trainers.
3. If Victor (to fly) to Timișoara, he would save almost a day.
4. What you (to do) if you (to be) a forester?
5. If our sportsmen (to have) better training conditions, they (to show) better results at the forthcoming competitions.
6. She (to envy) me if I (to go) to London this summer.

**7 Paraphrase the sentences below using the Subjunctive Mood after the verbs *suggest, demand, insist, propose, recommend and order*.**

1. My friend suggested us playing tricks on the first of April.
2. Father recommended me to join the City Artisanship Club.
3. Nick insisted on her travelling by air.
4. Mother proposed us to go on a picnic to the river at one of the forthcoming weekends.
5. The coach ordered the players to train in whatever the weather.

**8 Paraphrase the sentences below using the Subjunctive Mood after the verb *wish*.**

1. I am sorry I can't learn such a long poem.
2. What a pity not all my classmates will visit Great Britain this summer.
3. It's a pity I am not a poet.
4. What a pity my friend has some physical deficiencies.
5. It's a pity my father isn't as good at driving as my uncle is.
6. She is sorry her daughter doesn't want to play the piano.
7. It's a pity he doesn't speak German.
8. What a pity she can't keep secrets.
9. He is sorry he can't tell her the truth.
10. Her parents are sorry she doesn't know English.
11. It's a pity teenagers don't go to the theatre more often.

# A D J E C T I V E S

## 1 *Fill in the gaps with the right form of the adjectives.*

1. Life in the city is much ... than in the country. (fast)
2. Prague is one of ... cities in the world. (beautiful)
3. The ... food can be bought in this supermarket. (good)
4. Oxford University is one of ... universities in the world. (old)
5. It's ... to travel by trolleybus than by bus. (cheap)
6. This part of the city is ... one. (rich)
7. The ... sights of our city are in its eastern part. (attractive)
8. It's ... to walk through this park in the evening. (pleasant)
9. Madrid is ... than Rome. (expensive)
10. Ştefan-cel-Mare avenue is ... in Chişinău. (long)

## 2 *Use the right degree of the adjectives in brackets.*

1. That was ... party I had ever seen. (fantastic)
2. My mother is ... than her sister. (young)
3. The ... present for my mum is my good behaviour. (good)
4. The ... you love your mum, the ... you'll make her. (much, happy)
5. When she came home she found ... flowers on her table. (beautiful)
6. Her ... story is devoted to mothers. (good)
7. His poem was ... than mine. (profound)
8. Mothers and daughters should be on ... terms with each other. (friendly)
9. My mum cooks ... cookies in the world. (delicious)
10. The ... thing in the world is to be insensitive to mothers. (bad)

## 3 *Use the correct degree forms of the adjectives and adverbs given in brackets:*

1. My friend is the ... (bright) pupil in our class.
2. Victor knows English ... (well) than Pete.
3. The USA is one of the ... (big) countries in the world.
4. She is considered to be ... (beautiful) girl in their class.
5. Pupils need a much ... (large) school building.
6. San Francisco is ... (beautiful) than Chicago.
7. He always thought his father was ... (good) in the world.
8. Nick's English is ... (poor) than Andrew's.
9. Dan's father is very upset: his son has ... (bad) marks in maths.

## 4 *Write the correct comparison degree of the adjectives given in brackets:*

1. Today our team played (bad) than it did yesterday.
2. Of the two books my sister likes "Uncle Tom's Cabin" (little).
3. The new shop is (far) from my house than the old one.
4. Kate solved the problem (well) of all her classmates.
5. This is the (striking) building I have ever seen.
6. Of the three authors she writes (much) clearly.

# PREPOSITIONS

## 1 Fill in with the prepositions: *on, between, among, near, next to, in, under.*

- a) Don't keep tomatoes ... plastic bags for a long time.      d) There was a basket full of fruit ... .. the kitchen table.
- b) The campers sat for the picnic ... a big oak tree ... the lake.      e) A big crystal vase with bright flowers stood ... the cake and the tea pot ... the holiday table.
- c) Our famous singer Ion Suruceanu with his wife Nadia were ... the guests.

## 2 Choose the right preposition:

*with, for, over, between, out of, in, to, over, of, off*

1. She usually chooses shoes ... shape and fit.      6. He may not clean his boots ... several days.
2. He never buys shoes ... low quality.      7. Leather shoes need polishing ... good quality cream.
3. Slippers are soft shoes worn ... the house.      8. She had to choose ... high heeled and low heeled boots.
4. Sandals have straps ... the top of your feet.      9. I prefer moccasins ... sandals.
5. The Americans don't take their shoes ... when they enter a house.      10. Her toes were sticking ... her old shoes.

## 3 Use prepositions or adverbs.

My uncle is a young man. He is married and has two children. He plays cricket and football ... his local club and works ... an office. He usually walks ... his office. He has lunch ... a small restaurant ... his office. My uncle's office is not very large, there is a desk

... it and some chairs. ... the desk there is a shelf ... books and ... the centre ... the room there is a table. There is a vase ... flowers on it. ... the walls ... his room there are some pictures and a map.

## 4 Choose the right preposition and fill in the sentences below.

- My mum does her best to eliminate use of salt ... the table.
- Vegetables should be cooked ... a small amount of water.
- Eat salad ... the rest of the meal.
- There is a restaurant for vegetarians not ... our house.
- My dad likes to sprinkle chopped parsley ... the salad.
- I couldn't find the whisk ... my granny's kitchen utensils.
- There is a big table ... their dining room.
- The waitress placed his coffee ... the table ... him.
- The meat will be ready ... an hour.
- Will you pass me the mustard, please? It's ... the bread.

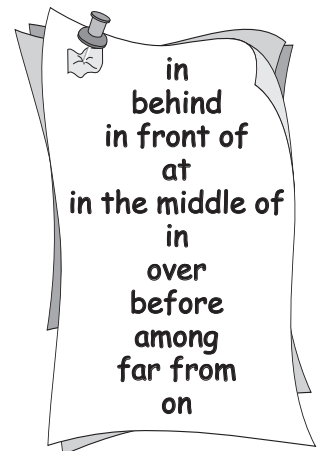

**5 Choose the correct preposition from the brackets.**

- Grown-ups don't believe (on / in) Father Christmas, but children do.
- We always go (to / in) bed late on New Year's Eve.
- The bride arrived (to / at) the church accompanied by close relatives.
- In Britain the bride and the groom have to go (at / to) the ceremony separately.
- The time of the wedding ceremony and the reception were both indicated (on / in) the invitation.
- You have to put money (in / into) the box (at / on) the entrance (at / to) the reception.
- When looking (to / at) her wedding photos my mum always smiles.
- When I got home (from / of) the party my parents were waiting (to / for) me.
- My dad brought (from / off) England a huge chocolate Easter egg (to / for) my little sister.
- Before Christmas he used to sit (in front of / opposite) the fire and write a letter (to / for) Father Christmas telling him (of / about) all the presents he wanted.

**6 Insert in with the prepositions: by, of, at, in, on, with, for.**

- Our teacher tells us not to be afraid ... experimenting new ideas.
- Young children are full ... enthusiasm and good will.
- We were impressed ... the actors' performance.
- She got interested ... producing films from an early age.
- The teachers and students of our school get ... well ... each other.
- Who is good ... acting on the stage in your class?
- We have been waiting ... this equipment since last week.
- It depends ... the film director whether the film is good or bad.
- As a rule a good, a curious pupil is always interested ... getting good knowledge.
- The cinema hall was full ... teachers and pupils.

**7 Fill in the gaps with the prepositions: in, for, from, of, to, far from, with.**

- As a young woman Marie Tussaud learned how to make wax figures. She was soon famous ... the masks that she made ... dead people's heads ... the French Revolution.
- King Louis XVI ... France and his wife Marie-Antoinette are just two ... the people who she modelled.
- She travelled ... Britain ... her wax figures ... 1802.
- ... 1835 she opened a museum ... her figures not ... the one you can still visit today.
- Most ... the figures that you can see today are new, but there are still some old ones, too.

**8 Fill in with the prepositions: of, in, on, to, from.**

- Sport is very popular ... Britain.
- ... other words, a lot ... British people like sport, especially watching it ... TV.
- However, the number of people who actively take part ... sport is quite small.
- ... the whole British people prefer to be fat rather than fit.
- The most popular and spectacular sport is football and it is played ... a Saturday afternoon ... most British towns and the fans, or supporters ... a particular team will travel ... one end ... the country ... the other to see their team play.

## SYNONYMS

### 1 Find synonyms for the following words:

|             |              |              |               |
|-------------|--------------|--------------|---------------|
| holiday –   | before –     | glad –       | amazed –      |
| start –     | high –       | to come to – | to find out – |
| wonderful – | to observe – | blond(e) –   | to enjoy –    |
| village –   | fortnight –  | kind –       | chance –      |

### 2 Find a synonym for each verb.

|                  |                  |                  |                    |
|------------------|------------------|------------------|--------------------|
| 1. to befriend – | 5. to cheat –    | 9. to last –     | 13. to present –   |
| 2. to quarrel –  | 6. to betray –   | 10. to help –    | 14. to accept –    |
| 3. to trust –    | 7. to need –     | 11. to offer –   | 15. to encourage – |
| 4. to argue –    | 8. to break up – | 12. to support – | 16. to pity –      |

### 3 Give synonyms for:

|                  |                       |                  |                     |
|------------------|-----------------------|------------------|---------------------|
| 1. to admire –   | 5. to prefer –        | 9. to arrange –  | 13. to practise –   |
| 2. to sculpt –   | 6. to be fond of –    | 10. to iron –    | 14. to surprise –   |
| 3. to carve –    | 7. to take pictures – | 11. to advance – | 15. to exhibit –    |
| 4. to ornament – | 8. to learn –         | 12. to develop – | 16. to appreciate – |

## ANTONYMS

### 1 Give antonyms for:

|                          |                    |               |                 |
|--------------------------|--------------------|---------------|-----------------|
| 1. hygienic –            | 5. smelling –      | 9. imported – | 13. infected –  |
| 2. greasy (hair, skin) – | 6. fresh (smell) – | 10. natural – | 14. useful –    |
| 3. dry –                 | 7. healthy –       | 11. liquid –  | 15. pleasant –  |
| 4. rough –               | 8. effective –     | 12. regular – | 16. necessary – |

### 2 Give antonyms for:

|                  |              |              |                    |
|------------------|--------------|--------------|--------------------|
| 1. comfortable – | 5. tight –   | 9. soft –    | 13. warm –         |
| 2. large-sized – | 6. stylish – | 10. heeled – | 14. high quality – |
| 3. high-heeled – | 7. light –   | 11. dark –   | 15. packed –       |
| 4. men shoes –   | 8. new –     | 12. cheap –  | 16. hand-made –    |



**3 Give the female opposites. Write the opposite gender.**

- |                        |                     |               |                  |
|------------------------|---------------------|---------------|------------------|
| 1. biological father – | 5. orphan –         | 9. grandson – | 13. cousin –     |
| 2. boy friend –        | 6. spouse –         | 10. uncle –   | 14. nephew –     |
| 3. school boy –        | 7. brother-in-law – | 11. husband – | 15. god-father – |
| 4. step-father –       | 8. prince –         | 12. widower – | 16. king –       |

**4 Give antonyms for:**

- |             |                        |              |                   |
|-------------|------------------------|--------------|-------------------|
| colourful – | black and white (TV) – | synthetic –  | attractive –      |
| white –     | pale –                 | favourable – | characteristic –  |
| light –     | pleasant –             | changeable – | identical –       |
| gloomy –    | quiet –                | adequate –   | distinguishable – |

**5 Give antonyms for:**

- |               |                         |                  |                    |
|---------------|-------------------------|------------------|--------------------|
| 1. friendly – | 5. generous –           | 9. sympathetic – | 13. caring –       |
| 2. sincere –  | 6. devoted / faithful – | 10. stable –     | 14. helpful –      |
| 3. honest –   | 7. reliable –           | 11. rational –   | 15. affectionate – |
| 4. candid –   | 8. courageous –         | 12. tolerant –   | 16. true –         |

**6 Give antonyms for:**

- |                    |                    |                     |                    |
|--------------------|--------------------|---------------------|--------------------|
| weak tea –         | light meal –       | home made bread –   | traditional food – |
| dry wine –         | brown bread –      | pickled cucumbers – | adequate lunch –   |
| white wine –       | unripe fruit –     | meat food –         | delicious food –   |
| alcoholic drinks – | fresh vegetables – | low-fat food –      | exceptional dish – |

**7 Give antonyms for:**

- |                |               |                      |                   |
|----------------|---------------|----------------------|-------------------|
| 1. highland –  | 5. mountain – | 9. single mountain – | 13. forest –      |
| 2. queen –     | 6. land –     | 10. single island –  | 14. aristocrats – |
| 3. north –     | 7. east –     | 11. ocean –          | 15. rock –        |
| 4. continent – | 8. hill –     | 12. river –          | 16. country –     |

**8 Give antonyms for:**

- |                 |                 |               |                    |
|-----------------|-----------------|---------------|--------------------|
| 1. advantage –  | 5. pavement –   | 9. city –     | 13. conveniences – |
| 2. avenue –     | 6. polluted –   | 10. work –    | 14. rush-hours –   |
| 3. pedestrian – | 7. excitement – | 11. pluses –  | 15. weekday –      |
| 4. walk (ing) – | 8. variety –    | 12. citizen – | 16. church –       |

**9 Give antonyms for:**

- |               |                  |                  |                 |
|---------------|------------------|------------------|-----------------|
| 1. comedy –   | 5. the stalls –  | 9. drama –       | 13. dramatist – |
| 2. composer – | 6. gallery –     | 10. monologue –  | 14. success –   |
| 3. bit part – | 7. interesting – | 11. minor role – | 15. joy –       |
| 4. to enjoy – | 8. actor –       | 12. spectators – | 16. happy –     |

## PREPOSITIONS

|                              |                       |                           |
|------------------------------|-----------------------|---------------------------|
| to be absent from            | to be interested in   | to get to / back from     |
| to accuse of                 | to be involved in     | to be tempted to          |
| to be angry with / at        | to be known for       | to be fond of             |
| to be acquainted with        | to look forward to    | to be jealous of          |
| to be addicted to            | to be made of / from  | to be envious of          |
| to agree with                | to object to          | to extend to              |
| to apologize for             | to participate in     | to bring up               |
| to apply to / for            | to be patient with    | to graduate from          |
| to argue with / about        | to be polite to       | to be inclined to         |
| to arrive in / at            | to play for / to      | to result in              |
| to be capable of             | to prevent from       | to share with             |
| to care about / for          | to prohibit from      | to seem to                |
| to compare to / with         | to protect from       | to clear up               |
| to be composed of            | to provide with       | to feel sorry for         |
| to consist of                | to be proud of        | to be in love with        |
| to contribute to             | to recover from       | to fight for              |
| to be convinced of           | to be related to      | to burst out crying       |
| to count up / on / out       | to rely on            | to burst into tears       |
| to decide up / on            | to rescue from        | to move to tears          |
| to be dedicated to           | to be responsible for | to extend to              |
| to be devoted to             | to be satisfied with  | to breathe in / out       |
| to depend on / upon          | to be scared of       | to enter somewhere        |
| to be disappointed in / with | to stare at           | to increase in            |
| to be divorced from          | to subscribe to       | to decline in             |
| to be done with              | to substitute for     | to lead to                |
| to be dressed in             | to succeed in         | to force upon             |
| to be engaged to             | to take care of       | to respond to             |
| to be equipped with          | to be tired of / from | to be allergic to         |
| to escape from               | to vote for           | to suffer from            |
| to excel in                  | to be worried about   | to complain of / about    |
| to be excited about          | to be afraid of       | to find faults with smb.  |
| to excuse for                | to get rid of         | to believe in smb.        |
| to be faithful to            | to name after         | to be suspicious of       |
| to be familiar with          | to originate from     | to be indifferent to smb. |
| to be grateful to / for      | to be angry with / at | to burst out laughing     |
| to be guilty of              | to be suitable for    | to keep in time           |
| to hide from                 | to keep the eye on    | to disagree about         |
| to be innocent of            | to give up            | to progress in            |
| to insist on                 | to share with         |                           |

# H O M O P H O N E S

|   |   |
|---|---|
| all ready – prepared                              | past – time before the present                |
| already – by or before this or that time          | passed – past tense of "to pass"              |
| bare – uncovered                                  | pale – not strong in colour                   |
| bear – to carry (v), to give birth; an animal (n) | pail – a bucket made of metal or wood         |
| board – a wooden plank (n), to get on a plane (v) | plain – simple, flat (area)                   |
| bored – uninterested                              | plane – a) an aircraft; b) a carpenter's tool |
| born – brought into life                          | rain – precipitation                          |
| borne – carried (Part II of "bear")               | reign – to rule                               |
| brake – device for stopping (n)                   | rein – leather straps for a horse's bridle    |
| break – to destroy, smash (v)                     | to raise – to lift up                         |
| coarse – not smooth                               | to raze – to destroy                          |
| course – a class                                  | rays (n) – beams of heat or light             |
| desert – to abandon                               | read – past form of to read                   |
| dessert – sweet course                            | red – the colour of blood                     |
| elicit – to get info                              | right (adj) – correct                         |
| illicit – illegal                                 | a rite – a ritual                             |
| fir – evergreen tree                              | to write – to put words on paper              |
| fur – soft, thick hair, covering animals          | road – street, highway                        |
| hair – thread like growth on the skin             | rode – past tense of ride                     |
| hare – animal like a rabbit                       | to sail – to travel in a boat or ship         |
| hear – to perceive (a sound)                      | sale (n) – selling of goods                   |
| here – in / at / to this place                    | sea – a large area of salty water             |
| heel (n) – back part of the foot                  | see – perceive with the eyes                  |
| heal (v) – make or become well                    | sight – ability to see; smth worth seeing     |
| hole – a hollow in smth. solid                    | site – location or scene                      |
| whole – intact/complete                           | so – in such a manner; very; also             |
| lead – a soft, grey, heavy metal                  | sow – to plant seeds (in the ground)          |
| led – Part II of "lead"                           | sew – to join (fasten) with needle and thread |
| maybe – perhaps                                   | son – a male offspring / descendant           |
| may be – might be                                 | sun – a star that the Earth goes round        |
| meat – flesh                                      | storey – floor or level of a building         |
| meet – to encounter                               | story – narration                             |
| our – belonging to us                             | through – from end to end of; during          |
| hour – sixty minutes                              | threw – (the) past tense of throw             |

# H O M O G R A P H S

- |  |   |
|--|---|
| <p>abuse &lt; [ə'bjʊ:z] (v) to treat smb. violently<br/>[ə'bjʊ:s] (n) the use of smth (bad purpose)</p>    | <p>intimate &lt; ['ɪntɪmeɪt] (v) to hint or imply<br/>['ɪntɪmət] (adj) close relation</p>       |
| <p>accent &lt; ['æksənt] (n) stress or emphases<br/>[æk'sent] (v) to emphasize</p>                         | <p>invalid &lt; [ɪn'veəlɪd] (adj) not correct<br/>[ɪn'vəlɪd] (n) disabled person</p>            |
| <p>axes &lt; ['æksɪz] pl. of axe<br/>[ˈæksɪ:z] pl. of axis</p>   | <p>lead &lt; [li:d] (v) to guide / go first<br/>[led] (n) grey, heavy metal (soft)</p>          |
| <p>bass &lt; [bæs] kind of fish<br/>[beɪs] low voice</p>   | <p>minute &lt; ['mɪnɪt] (n) part of an hour<br/>[maɪ'nju:t] (adj) very small, very careful</p>  |
| <p>bow &lt; [bau] (v) to bend your body<br/>[bəʊ] weapon</p>   | <p>moderate &lt; ['mɒdəreɪt] (v) to preside over a meeting<br/>[ˈmɒdərət] (adj) not extreme</p> |
| <p>close &lt; [kləʊz] (v) to shut<br/>[kləʊs] (adj) (to be) near</p>                                       | <p>object &lt; [ˈɒbdʒɪkt] (n) thing, purpose<br/>[ɒb'dʒekt] (v) to be against</p>               |
| <p>compound &lt; [kəm'paʊnd] (v) to mix or combine<br/>[ˈkɒmpaʊnd] (n) consisting of more things</p>       | <p>permit &lt; [pə:'mɪt] (v) to allow<br/>[ˈpɜ:mɪt] (n) official document</p>                   |
| <p>content &lt; ['kɒntent] (n) what is contained<br/>[kən'tent] (adj) happy</p>                            | <p>polish &lt; [pɒlɪʃ] (v) to make smth shine<br/>[ˈpɒlɪʃ] (adj) relating to Poland</p>         |
| <p>contract &lt; ['kɒntrækt] (n) formal agreement<br/>[kən'trækt] (v) to become smaller</p>                | <p>progress &lt; ['prəʊgres] (n) process of improving<br/>[ˈprɜ:gres] (v) to improve</p>        |
| <p>do &lt; [dəʊ] (n) musical note<br/>[du] (v) auxiliary verb</p>  | <p>project &lt; ['prɒdʒekt] (n) plan<br/>[ˈprɒdʒekt] (v) to stick out</p>                       |
| <p>dove &lt; [dɒv] (n) bird of peace<br/>[dəʊv] (v) past of dive (US)</p>                                  | <p>read &lt; [ri:d] (v) Pr. Simple of the verb<br/>[red] (v) Past Simple</p>                    |
| <p>down &lt; [daʊn] (adv) a lower place<br/>[daʊn] (n) soft fluff on a bird</p>                            | <p>refuse &lt; ['refju:s] (n) rubbish<br/>[rɪ'fju:z] (v) not to agree</p>                       |
| <p>evening &lt; ['i:vɪnɪŋ] (n) late afternoon<br/>[ɪ'vɛnɪŋ] making more even (smooth)</p>                  | <p>separate &lt; ['sepəreɪt] (adj) not connected<br/>[ˈsepəreɪt] (v) to keep apart</p>          |
| <p>finance &lt; [fɪ'næns] (v) provide money for<br/>[ˈfaɪnæns] (n) amount of money</p>                     | <p>sewer &lt; [səʊə] (n) person who sews<br/>[su:ə] (n) drain</p>                               |
| <p>frequent &lt; ['fri:kwənt] (adj) often occurring<br/>[ˈfrɪk'went] (v) to visit regularly</p>            | <p>sow &lt; [səʊ] (v) to plant seeds<br/>[sau] (n) female pig</p>                               |
| <p>import &lt; [ɪm'pɔ:t] (v) to bring from abroad<br/>[ˈɪmpɔ:t] (n) things brought from abroad</p>         | <p>subject &lt; [ˈsʌbdʒɪkt] (n) topic<br/>[səb'dʒekt] (v) to force a person to accept</p>       |
| <p>increase &lt; [ɪn'kri:s] (v) to become larger in amount<br/>[ˈɪnkri:s] (n) a rise in amount, number</p> | <p>tear &lt; [tɪə] (n) liquid from the eyes<br/>[teə] (v) to pull to pieces</p>                 |

## COMMONLY CONFUSED WORDS

accept – to agree to ...

except – other than

ant [ænt] – small crawling insect

aunt [a:nt] – your mother's or father's sister

advice [ə'dvaɪs] – recommendation

advise [ə'dvaɪz] – to recommend

affect – to have an influence on

effect – result (n); to cause

bear [beə] – strong wild animal

beer [biə] – bitter alcoholic drink

boat [bəʊt] – a small, open watercraft

bought [bɔ:t] – past tense and PII of buy

bat [bæt] – a mouselike, flying animal

bet [bet] – agreement

dare [deə] – to have enough courage for

dear [diə] – much loved

dark [dɑ:k] – without light

duck [dʌk] – water, bird

deaf [def] – unable to hear

death [deθ] – the end of someone's life

'desert [ˈdezət] – a dry, sandy region

dessert [di'zɜ:t] – the final course of a meal

hare [heə] – animal like a rabbit

here [hiə] – in this place

hat [hæt] – covering for the head

hurt [hɜ:t] – to cause pain

Ireland [ˈaɪələnd] – a country in north-west Europe

island [ˈaɪlənd] – a piece of land surrounded by water

Iceland [ˈaɪslənd] – a country in the North Atlantic

loose [lu:s] – (adj) not tight

lose [lu:z] – (v) not to have any more; to misplace

leave [li:v] – (v) to go away; to allow to remain

live [lɪv] – (v) to be alive

low [ləʊ] – (adj) not high or tall

law [lə:] – rules expected to be observed

maybe [meɪbi:] – perhaps

may be [meɪ 'bi:] – might be

nice [naɪs] – pleasant; kind

niece [ni:s] – daughter of one's sister or brother

paper [peɪpə] – you write on

pepper [ˈpepə] – hot-tasting powder; vegetable

patience [peɪjns] – (n) endurance, calmness

patients [peɪ'jnts] – persons receiving medical care

personal [ˈpɜ:snəl] – private; one's own

personnel [pɜ:sə'nel] – employees

precede [pri'si:d] – to come before

proceed [prə'si:d] – to continue

quiet [ˈkwaɪət] – silent

quite [ˈkwaɪt] – very

raw [rɔ:] – uncooked

roe [rəʊ] – small species of deer

so [səʊ] – in such a manner; very; also

sow [sau] – (n) an adult female pig

steel [sti:l] – strong metal (made from iron)

still [stɪl] – (adj) silent; (adv) even, yet

soap [səʊp] – substance used for washing

soup [su:p] – liquid food

tea [ti:] – hot drink

tear [tiə] – drop of liquid falling from the eye

ton [tʌn] – unit of weight = to 1016 kg

tonne [tʌn] – unit of weight equal to 1000 kg

tone [təʊn] – vocal or musical sound

## THE USA

The United States of America is one of the largest countries in the world. Its area of more than 9 mln. sq. km. is only a little smaller than the area of Europe. As to population, it is the fourth largest country in the world. More than 320 million people live there. The USA is made up of 50 different states. Two states – Alaska and Hawaii – are separated from the country. Alaska is to the North of the continent and is separated from the country by Canada. Hawaii lies in the central Pacific. The country is washed by the Atlantic Ocean in the east and by the Pacific Ocean in the west. It borders on Canada in the north and on Mexico in the south. The geographical position of the US makes it a country of great variety in landscape.

The north-eastern Atlantic coast is rocky, but its middle and southern part rises gently from the sea, passing from swamps into a rolling lowland. The USA is crossed by the Appalachian Mountains in the east and the Rocky Mountains in the west. The Appalachians are not high, but steep. The Rocky Mountains are high, sharp and rugged, and are rich in such minerals as gold, copper and silver. They are the main mountains of the Cordilleran Highlands.

There are many rivers and lakes in the US. The Mississippi that flows through the central plains to the Gulf of Mexico and gathers its waters from two-thirds of the US is one of the world's greatest rivers. It is about 6.210 km. long together with its main tributary, the Missouri River. The rivers in the west are unsuitable for navigation. The largest among them, the Columbia and the Colorado, flow through deep canyons.

In the north between the US and Canada the five Great Lakes lie: Lake Superior, Huron, Michigan, Erie and Ontario. The Great Lakes make up the largest

group of lakes in the country, as well as the greatest collection of fresh-water lakes in the world.

The capital of the USA is Washington, DC. The largest city in the USA is New York, it is also the biggest seaport. Other large cities in the USA are Chicago, Los Angeles, San Francisco, Seattle, Atlanta, Houston, Boston, Philadelphia, etc.

The US government consists of three main branches. The first branch is the Congress. The Congress is divided into two parts: the Senate and the House of Representatives. Every state, no matter how large or small, sends two people to the Senate. These people are called senators. There are one hundred senators in the Senate. A senator's term is six years. Each state also sends people to the House of Representatives. They are called congressmen or congresswomen. The number of congressmen from each state depends on the number of people who live in the state. The larger states have more congressmen. All in all there are 435 congressmen in the House of Representatives. A representative's term is two years. The Congress has the power to make laws.

The second branch of government is the President and his helpers. The Vice President and members of the Cabinet help the President to carry out the laws that the Congress makes. The US President is the Commander-in-Chief of the country's armed forces. The President's term is 4 years. Americans vote for the President in November of every leap year.

The third branch of government is the Supreme Court. It is made up of nine judges. They have to make sure that the President and the Congress follow the Constitution. The judges work in the Supreme Court as long as they live.



## AUSTRALIA

In land area, Australia is the sixth largest nation after Russia, Canada, China, the United States of America and Brazil. It has, however, a relatively small population.

Australia is the only nation to govern an entire continent and its outlying islands. The mainland is the largest island and the smallest, flattest continent on Earth. It lies between 10° and 39° South latitude.

The highest point on the mainland, Mount Kosciuszko, is only 2228 metres. Apart from Antarctica, Australia is the driest continent on earth. Its interior has one of the lowest rainfalls in the world and about three-quarters of the land is arid or semi-arid. Its fertile areas are well-watered, however, and these are used very effectively to help feed the world. Sheep and cattle graze in dry country, but care must be taken with the soil. Some grazing land became desert when the long cycles that influence rainfall in Australia turned to drought.

The Australian federation consists of six States and two Territories: New South Wales, Victoria,

Queensland, Western Australia, South Australia, Tasmania, Northern Territory and Australian Capital Territory. Canberra, the capital of Australia, is situated in the Australian Capital Territory.

The main cities of Australia are Sydney, a seaport; Melbourne, the cultural centre; Brisbane, a seaport; Perth, a seaport on the western coast; and Adelaide, an agricultural centre. Australia currently is the major world producer and exporter of wool and fruits such as grapes, oranges, apples, bananas, pears, pineapples, peaches and nectarines.

With its abundant physical resources, Australia has enjoyed a high standard of living since the nineteenth century. It has made a large investment in social infrastructure, including education, training, health and transport.

Education in Australia is the responsibility of each state apart. It is compulsory between the ages of 6 and 15. About 75% of students attend state schools. Among the leading universities are the Australian National University, the University of Sydney, Queensland, Adelaide, Tasmania, Melbourne etc.



Culture, although based on the British tradition, is unique to Australia. It has always been promoted by the government. A lot of art galleries and performing art centres end, film studios have been built in Australia. The Sydney Opera House is one of the best known architecturally stunning (uluitor) buildings in the world. Artists, playwrights, writers, opera, ballet, dance companies, symphony orchestras are supported by the Australian Government.

Australia is a land of striking differences with its unique and primitive forms of animal life. About 70% of birds, 88% of reptiles and 94% of the frogs are characteristic only to Australia. Australia is the home of the duckbill and the anteater – two of the world's

most primitive mammals, being the only mammals that lay eggs.

Among other animals and birds found in Australia are the kangaroo, the koala, the dingo, the emu, the kookaburra, (so called the “laughing jackass”), beautifully coloured parrots and, of course, the graceful lyrebird.

Australia is a far away country and continent, but no matter how far it is, people have always been attracted to this amazing land. Those who are fond of travelling would gladly like to visit this piece of land because Australia is such an extraordinary place to explore!





## CANADA

Canada is situated in North America. It consists of ten provinces and three territories. Being located in the northern part of the continent, Canada extends from the Arctic Ocean to the United States, and from the Atlantic Ocean to the Pacific Ocean. Canada is the largest country in North America and the second largest in the world after Russia. Occupying an extremely vast territory, Canada has six time zones.



A considerable part of Canada's territory is covered with forests, and this made possible for the country to become a major exporter of timber, wood pulp and newsprint. The fishing industry is characteristic of Canada as well as effective farming. Regarding finances, Canada has a well developed banking and insurance system.

The country's capital city is Ottawa, which is in Ontario on the border with Quebec. Known as New France, Quebec became a royal province of the French Crown (1663). In 1763, Canada was ceded (cedatã) to Britain and defined as an independent constitutional monarchy equal in status to Britain in the Commonwealth. The Canadian Federal

Parliament has two Houses – the Senate of 118 members, appointed by the Governor General, and the House of Commons, whose 295 members are elected for five years. The Prime Minister is appointed by the Governor General, who is the representative of the British Queen as sovereign of Canada. The Cabinet of Ministers is nominated by the Prime Minister. Each province, in turn, has its own government and

legislature. Canada has two official languages: English and French.

With the population of over 35 million people, Canada has earned international respect for its strong diplomatic skills, peacekeeping efforts, and for respect of human rights. The people here enjoy a very high standard of life owing, in part, to rich mineral resources of gold, silver, iron ore, nickel, copper, cobalt, uranium, lead [led] (plumb), zinc as well as petroleum and natural gas.

There are many cities in Canada such as: Toronto, Montreal, Ottawa, Vancouver,



Quebec, Calgary, Winnipeg, Edmonton, etc... Canada, being one of the world's wealthiest countries and an important tourist destination, attracts millions of people from all over the world. Some of most visited places in Canada are the Niagara Falls (51 m. high) and the observation CN Tower (553.33 m. high) in Toronto.

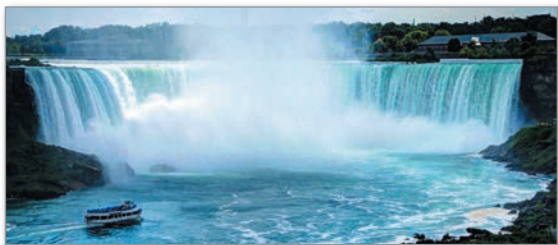

## NEW ZEALAND

New Zealand is situated in the Pacific Ocean, lying in the south-east of Australia. Its total area covers 270.534 square kilometres, and its population is only 3.5 million people. Being formed of two main islands, North Island and South Island, and other smaller islands, New Zealand's territory is as big as that of Japan, Chile and Italy, and a little larger than that of the United Kingdom. New Zealand is a very beautiful

the longest – its length is 435 km, and Lake Taupo is the largest. On the islands there is a big number of thermal springs and volcanoes. People often call New Zealand “The Shaky Isles” for their frequent seismic activity. There's a specific thing to be mentioned about plant and animal life in New Zealand, where most of its fauna and flora is indigenous (90 percent). Yet, there are many species that were imported. Here, on the islands, one can



country, called “God's own country” and the “Paradise of the Pacific.” Wellington, with a population of 200.100 people, is the country's capital. Although it formerly was a part of the British Empire, New Zealand is now a self-governing state.

The Parliament of New Zealand consists of one House only – the House of Representatives. The Prime Minister is the head of the government. The official language is English.

The climate in New Zealand is humid. Winters here are rather cold in the south and mild in the north. There are lots of mountains in New Zealand – the highest one is Mount Cook (3.374 m.). There are lots of rivers and large lakes on both islands, too. The Waikato River is

see peculiar species of trees, like kauri trees, and birds such as the largest flightless parrot, the flightless kiwi, the oldest reptile (tuatara) dating back to the dinosaurs time, etc... The kiwi bird has become the symbol of people there – little children are called kiwis. New Zealand is rich in minerals that help people develop heavy industry – like iron and steel industry. It has gas and petroleum as well. New Zealand is an exporter of butter, meat and wool.

There are some big towns in New Zealand: Auckland, Christchurch, Denedin, Nelson. Auckland and Wellington are the main seaports. Being famous for many regions that are worth seeing, New Zealand is, finally, a country of great interest owing mostly to its uniqueness and commonness at the same time.

## HOME, SWEET HOME

'Mid pleasures and palaces though I may roam<sup>1</sup>  
 Be it ever so humble<sup>2</sup> there's no place like home.  
 A charm<sup>3</sup> from the sky seems to hallow<sup>4</sup> us there  
 Which seek thro' the world is ne'er met with elsewhere.

Home, home, sweet, sweet home,  
 There's no place like home,  
 There's no place like home.

To thee<sup>5</sup> I'll return overburdened<sup>6</sup> with care,  
 The heart's dearest face will smile on me there,  
 No more from that cottage again will I roam,  
 Be it ever so humble there's no place like home.

*By J. Howard*

<sup>1</sup> to roam [rəʊm] v. – a hoinări

<sup>2</sup> humble [hʌmbəl] adj. – modest

<sup>3</sup> charm [tʃɑ:m] n. – frumusețe

<sup>4</sup> to hallow ['hæləʊ] v. – a sfinți, a cinsti

<sup>5</sup> thee [ði:] pron. = you

<sup>6</sup> to burden [bɜ:dn] v. – a împovăra

## TREES

Trees are the kindest things I know,  
 They do no harm, they simply grow  
 And spread a shade for sleepy cows,  
 And gather birds among their boughs<sup>1</sup>.

They give us fruit in leaves above,  
 And wood to make our houses of,  
 And leaves to burn on Hallowe'en,  
 And in the Spring new buds of green.

They are the first when day's begun  
 To touch the beams<sup>2</sup> of morning sun,  
 They are the last to hold the light  
 When evening changes into night,

When a moon floats<sup>3</sup> on the sky  
 They hum a drowsy lullaby<sup>4</sup>  
 Of sleepy children long ago  
 Trees are the kindest things I know.

*Harry Behn*

<sup>1</sup> bough [bau] n. – creangă

<sup>2</sup> beam [bi:m] n. – rază

<sup>3</sup> to float [fləʊt] v. – a pluti (pe cer)

<sup>4</sup> to hum a drowsy ['drauzi] lullaby ['lʌləbaɪ] – a fredona un cântec de leagăn

## THE SHIPS

For many a year I've watched the ships  
 a-sailing to and fro<sup>1</sup>,  
 The mighty ships, the little ships,  
 the speedy and the slow;  
 And many a time I've told myself that  
 some day I would go  
 Around the world that is so full of wonders.  
 The things I've heard, the things I've read,  
 the things I've dreamed might be.  
 The boyish tales, the old men's yarns<sup>2</sup> –  
 they will not pass from me:  
 I've heard, I've read, I've dreamed – but  
 all the time I've longed<sup>3</sup> to see –  
 Around the world that is so full of wonders.  
 So year by year I watch the ships  
 a-sailing to and fro,  
 The ships that come as strangers and the ships  
 I've learned to know.  
 Folks<sup>4</sup> smile to hear me say that some day  
 I will go  
 Around the world that is so full of wonders.

*J. J. Bell*

<sup>1</sup> to and fro [frəʊ] – încolo, înapoi

<sup>2</sup> yarn [jɑ:n] n. – povestire

<sup>3</sup> to long [lɔŋ] v. – a dori mult

<sup>4</sup> folks [fəʊks] n. – oameni

## IT'S NEVER FAIR WEATHER

I do not like the winter wind  
 That whistles from the North.  
 My upper teeth and those beneath,  
 They jitter<sup>1</sup> back and forth.  
 Oh, some are hanged, and some are skinned.  
 And others face the winter wind.

I do not like the summer sun  
 That scorches<sup>2</sup> the horizon.  
 Though some delight in Fahrenheit,  
 To me it's deadly poison.  
 I think life would be more fun  
 Without the simmering<sup>3</sup> summer sun.

I do not like the signs of spring.  
The fever and the chills,  
The icy mud, the puny<sup>4</sup> bud,  
The frozen daffodils.  
Let other poets gaily sing:  
I do not like the signs of spring.

I do not like the foggy fall  
That strips the maples bare;  
The radiator's mating call,  
The damp rheumatic air.  
I fear that taken all in all  
I do not like the foggy fall.

The winter sun, of course, is kind,  
And summer wind's a savior<sup>5</sup>,  
And I'll merrily sing of fall and spring  
When they're on their good behaviour.  
But otherwise I see no reason  
To speak in praise of any season.

*Ogden Nash*

<sup>1</sup> to jitter ['dʒɪtə] v. – a se agita

<sup>2</sup> to scorch [skɔ:tʃ] v. – a schimba culoarea

<sup>3</sup> to simmer ['sɪmə] v. – a înfierbânta

<sup>4</sup> puny [pju:ni] adj. – mic, slab

<sup>5</sup> savior ['seɪvjə] n. – salvator

### STOPPING BY WOODS ON A SNOWY EVENING

Whose woods these are I think I know.  
His house is in the village though;  
He will not see me stopping here  
To watch his woods fill up with snow.

My little horse must think it queer  
To stop without a farmhouse near  
Between the woods and frozen lake  
The darkest evening of the year.

He gives his harness bells a shake  
To ask if there is some mistake.  
The only other sound's the sweep  
Of easy wind and downy flake.

The woods are lovely, dark and deep.  
But I have promises to keep,  
And miles to go before I sleep,  
And miles to go before I sleep.

*By Robert Frost*

### MY HEART'S IN THE HIGHLANDS

My heart's in the Highlands, my heart is not here,  
My heart's in the Highlands a-chasing<sup>1</sup> the deer,  
A-chasing the wild deer and following the roe<sup>2</sup> –  
My heart's in the Highlands, wherever I go!

Farewell<sup>3</sup> to the Highlands, farewell to the North,  
The birthplace of valour<sup>4</sup>, the country of worth!  
Wherever I wander, wherever I rove<sup>5</sup>,  
The hill of the Highlands for ever I love

Farewell to the mountains high cover'd with snow,  
Farewell to the straths<sup>6</sup> and green valleys below,  
Farewell to the forests and wild-hanging woods,  
Farewell to the torrents and long-pouring floods!

My heart's in the Highlands, my heart is not here,  
My heart's in the Highlands a-chasing the deer,  
A-chasing the wild deer and following the roe –  
My heart's in the Highlands, wherever I go!

*R. Burns*

<sup>1</sup> to chase [tʃeɪs] v. – a urmări, a goni

<sup>2</sup> roe [rəʊ] n. – căprioară

<sup>3</sup> farewell ['feə'wel] int. – adio

<sup>4</sup> valour ['vælə] n. – curaj, bărbăție

<sup>5</sup> to rove [rəʊv] v. – a hoinări, a rătăci

<sup>6</sup> strath [stræθ] n. – melodie de dans popular

### LEISURE

What is this life if, full of care,  
We have no time to stand and stare?  
No time to stand beneath the boughs  
And stare as long as sheep or cows.  
No time to see when woods we pass,  
Where squirrels hide their nuts in grass.  
No time to see, in broad daylight,  
Streams full of stars, like skies at night.  
No time to turn at Beauty's glance,  
And watch her feet, how they can dance.  
No time to wait till her mouth can  
Enrich that smile her eyes began.  
A poor life this is if, full of care,  
We have no time to stand and stare.

*By W. H. Davies*

|                  |                    |                     |                          |                           |
|------------------|--------------------|---------------------|--------------------------|---------------------------|
| be [bi:]         | was/were [wɒz/wɜ:] | been [bi:n]         | a fi, a exista           | быть                      |
| beat [bi:t]      | beat [bi:t]        | beaten [bi:tn]      | a bate, a lovi           | бить                      |
| become [bi'kʌm]  | became [bi'keɪm]   | become [bi'kʌm]     | a deveni                 | стать, становиться        |
| begin [bi'gɪn]   | began [bi'gæn]     | begun [bi'gʌn]      | a începe                 | начинать                  |
| bend [bend]      | bent [bent]        | bent [bent]         | a îndoii, a se apleca    | наклонять(ся)             |
| blow [bləʊ]      | blew [blu:]        | blown [bləʊn]       | a sufla                  | дуть                      |
| break [breɪk]    | broke [brəʊk]      | broken ['brəʊkən]   | a frînge, a strica       | бить, ломать(ся)          |
| breed [bri:d]    | bred [bred]        | bred [bred]         | a creşte (animale)       | выводить, разводить       |
| bring [brɪŋ]     | brought [brɔ:t]    | brought [brɔ:t]     | a aduce, a produce       | приносить                 |
| build [bɪld]     | built [bɪlt]       | built [bɪlt]        | a clădi                  | строить                   |
| burn [bɜ:n]      | burnt [bɜ:nt]      | burnt [bɜ:nt]       | a arde, a frige          | гореть, жечь              |
| buy [baɪ]        | bought [bɔ:t]      | bought [bɔ:t]       | a cumpăra                | покупать                  |
| catch [kætʃ]     | caught [kɔ:t]      | caught [kɔ:t]       | a prinde, a apuca        | ловить, хватать           |
| choose [tʃu:z]   | chose [tʃəʊz]      | chosen ['tʃəʊzən]   | a alege                  | выбирать                  |
| come [kʌm]       | came [keɪm]        | come [kʌm]          | a veni                   | приходить                 |
| cost [kɒst]      | cost [kɒst]        | cost [kɒst]         | a costa                  | стоить                    |
| cut [kʌt]        | cut [kʌt]          | cut [kʌt]           | a tăia, împărţi          | резать                    |
| dig [dɪg]        | dug [dʌg]          | dug [dʌg]           | a săpa                   | копать                    |
| do [du:]         | did [dɪd]          | done [dʌn]          | a face, a săvârşi        | делать                    |
| draw [drɔ:]      | drew [dru:]        | drawn [drɔ:n]       | a desena                 | рисовать                  |
| dream [dri:m]    | dreamt [dremt]     | dreamt [dremt]      | a visa, a-şi închipui    | мечтать                   |
| drink [drɪŋk]    | drank [dræŋk]      | drunk [drʌŋk]       | a bea                    | пить, выпить              |
| drive [draɪv]    | drove [drəʊv]      | driven ['drɪvən]    | a conduce, a mîna        | водить машину             |
| eat [i:t]        | ate [et], [eɪt]    | eaten [i:tn]        | a mânca                  | есть, кушать              |
| fall [fɔ:l]      | fell [fel]         | fallen ['fɔ:lən]    | a cădea                  | падать                    |
| feed [fi:d]      | fed [fed]          | fed [fed]           | a alimenta, a întreţine  | кормить                   |
| feel [fi:l]      | felt [felt]        | felt [felt]         | a simţi, a pipăi         | чувствовать               |
| fight [faɪt]     | fought [fɔ:t]      | fought [fɔ:t]       | a se lupta cu            | бороться, сражаться       |
| find [faɪnd]     | found [faʊnd]      | found [faʊnd]       | a (se) găsi              | находить                  |
| fly [flaɪ]       | flew [flu:]        | flown [fləʊn]       | a zbura                  | летать                    |
| forget [fə'get]  | forgot [fə'gɒt]    | forgotten [fə'gɒtn] | a uita                   | забывать                  |
| forgive [fə'gɪv] | forgave [fə'gɪv]   | forgiven [fə'gɪvən] | a ierta                  | прощать                   |
| freeze [fri:z]   | froze [frəʊz]      | frozen ['frəʊzən]   | a îngheţa                | замерзать                 |
| get [get]        | got [gɒt]          | got [gɒt]           | a căpăta, a procura      | получать                  |
| give [gɪv]       | gave [gɪv]         | given ['gɪvən]      | a da                     | давать                    |
| go [gəʊ]         | went [went]        | gone [gɒn]          | a merge                  | идти                      |
| grow [grəʊ]      | grew [gru:]        | grown [grəʊn]       | a creşte                 | расти                     |
| hang [hæŋ]       | hung [hʌŋ]         | hung [hʌŋ]          | a atîrna                 | висеть                    |
| have [hæv]       | had [hæd]          | had [hæd]           | a avea                   | иметь                     |
| hear [hɪə]       | heard [hɜ:d]       | heard [hɜ:d]        | a auzi, a asculta        | слышать                   |
| hide [haɪd]      | hid [hɪd]          | hidden [hɪdn]       | a (se) ascunde           | прятать(ся)               |
| hit [hɪt]        | hit [hɪt]          | hit [hɪt]           | a lovi                   | ударить(ся)               |
| hold [həʊld]     | held [held]        | held [held]         | a (sus) ţine, a menţine  | держать                   |
| hurt [hɜ:t]      | hurt [hɜ:t]        | hurt [hɜ:t]         | a răni, a jigni          | причинять боль            |
| keep [ki:p]      | kept [kept]        | kept [kept]         | a ţine, a păstra         | держать, хранить          |
| know [nəʊ]       | knew [nju:]        | known [nəʊn]        | a şti, a cunoaşte        | знать                     |
| lay [leɪ]        | laid [leɪd]        | laid [leɪd]         | a pune, a aşterne (masa) | класть, накрыть (на стол) |
| lead [li:d]      | led [led]          | led [led]           | a (con) duce, a governa  | вести, руководить         |
| learn [lɜ:n]     | learnt [lɜ:nt]     | learnt [lɜ:nt]      | a învăţa, a afla         | учить                     |
| leave [li:v]     | left [left]        | left [left]         | a părăsi, a lăsa în urmă | покидать, оставлять       |
| lend [lend]      | lent [lent]        | lent [lent]         | a da cu împrumut         | давать взаймы, одалживать |

|                             |                            |                            |                               |                                    |
|-----------------------------|----------------------------|----------------------------|-------------------------------|------------------------------------|
| let [let]                   | let [let]                  | let [let]                  | a lăsa, a permite             | позволять                          |
| lie [laɪ]                   | lay [leɪ]                  | lain [leɪn]                | a sta întins                  | лежать                             |
| lose [lu:z]                 | lost [lɒst]                | lost [lɒst]                | a pierde                      | терять                             |
| make [meɪk]                 | made [meɪd]                | made [meɪd]                | a face, a sili                | делать, заставлять                 |
| mean [mi:n]                 | meant [ment]               | meant [ment]               | a se referi la, a însemna     | означать, иметь в виду             |
| meet [mi:t]                 | met [met]                  | met [met]                  | a (se) întâlni                | встречать(ся)                      |
| overcome<br>[,əʊvə'kʌm]     | overcame<br>[,əʊvə'keɪm]   | overcome<br>[,əʊvə'kʌm]    | a învinge                     | преодолевать                       |
| pay [peɪ]                   | paid [peɪd]                | paid [peɪd]                | a plăti, a achita             | платить, оплачивать                |
| put [pʊt]                   | put [pʊt]                  | put [pʊt]                  | a pune                        | класть, положить                   |
| read [ri:d]                 | read [red]                 | read [red]                 | a citi                        | читать                             |
| ride [raɪd]                 | rode [rəʊd]                | ridden [rɪdn]              | a călări, a mîna              | ехать верхом                       |
| ring [rɪŋ]                  | rang [ræŋ]                 | rung [rʌŋ]                 | a suna (la sonerie, telefon)  | звонить                            |
| rise [raɪz]                 | rose [rəʊz]                | risen ['rɪzən]             | a se ridica, a răsări         | подниматься, в(о)сходить           |
| run [rʌn]                   | ran [ræn]                  | run [rʌn]                  | a alerga, a curge, a dura     | бежать, течь, длиться (о песе)     |
| say [seɪ]                   | said [sed]                 | said [sed]                 | a zice, a afirma              | сказать                            |
| see [si:]                   | saw [sɔ:]                  | seen [si:n]                | a vedea                       | видеть                             |
| send [send]                 | sent [sent]                | sent [sent]                | a trimite                     | посылать                           |
| set [set]                   | set [set]                  | set [set]                  | a instala, a apune            | устанавливать, садиться (о солнце) |
| sew [səʊ]                   | sewed [səʊd]               | sewn [səʊn]                | a coase                       | шить                               |
| shake [ʃeɪk]                | shook [ʃʊk]                | shaken ['ʃeɪkən]           | a (se) scutura                | трясти(сь), стряхивать             |
| shine [ʃaɪn]                | shone [ʃɒn]                | shone [ʃɒn]                | a străluci                    | сверкать, сиять                    |
| shoot [ʃu:t]                | shot [ʃɒt]                 | shot [ʃɒt]                 | a filma; a împuşca            | снимать (фильм); стрелять          |
| show [ʃəʊ]                  | showed [ʃəʊd]              | shown [ʃəʊn]               | a arăta                       | показывать                         |
| sing [sɪŋ]                  | sang [sæŋ]                 | sung [sʌŋ]                 | a cânta                       | петь                               |
| sit [sɪt]                   | sat [sæt]                  | sat [sæt]                  | a şede, a sta                 | сидеть                             |
| sleep [sli:p]               | slept [slept]              | slept [slept]              | a dormi                       | спать                              |
| smell [smel]                | smelt [smelt]              | smelt [smelt]              | a mirosi                      | пахнуть, нюхать                    |
| speak [spi:k]               | spoke [spəʊk]              | spoken ['spəʊkən]          | a vorbi                       | разговаривать                      |
| spell [spel]                | spelt [spelt]              | spelt [spelt]              | a citi literă cu literă       | называть слово по буквам           |
| spend [spend]               | spent [spent]              | spent [spent]              | a consuma, a petrece (timpul) | тратить, проводить (время)         |
| stand [stænd]               | stood [stʊd]               | stood [stʊd]               | a sta, a se afla              | стоять                             |
| steal [sti:l]               | stole [stəʊl]              | stolen ['stəʊlən]          | a fura                        | красть                             |
| stick [stɪk]                | stuck [stʌk]               | stuck [stʌk]               | a lipi                        | приклеивать                        |
| strike [straɪk]             | struck [strʌk]             | struck [strʌk]             | a lovi                        | ударять                            |
| strive [straɪv]             | strove [strəʊv]            | striven ['strɪvən]         | a se strădui, a tinde         | стараться, стремиться              |
| sweep [swi:p]               | swept [swept]              | swept [swept]              | a mătura                      | подметать                          |
| swim [swɪm]                 | swam [swæm]                | swum [swʌm]                | a înota, a pluti              | плавать                            |
| take [teɪk]                 | took [tʊk]                 | taken ['teɪkən]            | a lua                         | брать                              |
| teach [ti:tʃ]               | taught [tɔ:t]              | taught [tɔ:t]              | a predă, a învăţa             | учить, обучать                     |
| tear [tiə]                  | tore [tɔ:]                 | torn [tɔ:n]                | a rupe, a sfîşia              | рвать                              |
| tell [tel]                  | told [təʊld]               | told [təʊld]               | a relata, a spune             | сказать, рассказывать              |
| think [θɪŋk]                | thought [θɔ:t]             | thought [θɔ:t]             | a gândi                       | думать                             |
| throw [θrəʊ]                | threw [θru:]               | thrown [θrəʊn]             | a arunca                      | бросать                            |
| understand<br>[,ʌndə'stænd] | understood<br>[,ʌndə'stʊd] | understood<br>[,ʌndə'stʊd] | a înţelege                    | понимать                           |
| upset [ʌp'set]              | upset [ʌp'set]             | upset [ʌp'set]             | a răsturna, a necăji          | перевернуть, огорчать(ся)          |
| wake [weɪk]                 | woke [wəʊk]                | woken ['wəʊkən]            | a (se) trezi                  | проснуться                         |
| wear [weə]                  | wore [wɔ:]                 | worn [wɔ:n]                | a purta                       | носить (одежду)                    |
| weave [wi:v]                | wove [wəʊv]                | woven ['wəʊvən]            | a ţese                        | ткать                              |
| write [raɪt]                | wrote [rəʊt]               | written [rɪtn]             | a scrie                       | писать                             |

A

|                                    |                                      |                                  |
|------------------------------------|--------------------------------------|----------------------------------|
| ability [ə'bilɪti] (n)             | capacitate, pricepere                | способность, умение              |
| acacia [ə'keɪʃə] (n)               | salcîm                               | акация                           |
| to accessorize [ək'sæs(ə)raɪz] (v) | a folosi accesorii                   | использовать аксессуары          |
| accommodation [ə,kɒmə'deɪʃən] (n)  | spațiu locativ                       | жилье                            |
| accountant [ə'kaʊntənt] (n)        | contabil                             | бухгалтер                        |
| achieve [ə'tʃi:v] (v)              | a realiza, a dobîndi                 | достигать                        |
| actually ['æktʃuəli] (adv)         | de fapt                              | фактически                       |
| add [æd] (v)                       | a adăuga; a aduna                    | добавлять; прибавлять            |
| adequate ['ædɪkwət] (adj)          | corespunzător, adecvat               | соответствующий                  |
| admire [əd'maɪə] (v)               | a admira                             | восхищаться, любоваться          |
| advertisement [əd'vɜ:tɪsmənt] (n)  | anunț, reclamă                       | объявление, реклама              |
| advise [əd'vaɪz] (v)               | a sfătui, a povățui                  | советовать                       |
| affect [ə'fekt] (v)                | a afecta                             | влиять, действовать              |
| aim [eɪm] (n)                      | țel, scop                            | цель, намерение                  |
| air hostess ['eə'hɒstɪs] (n)       | stewardesă                           | стюардесса                       |
| alert [ə'li:t] (v)                 | a alerta, a pune în stare de alarmă, | привести в состояние готовности, |
| alter ['ɔ:lteɪ]                    | a modifica                           | переделывать                     |
| amount [ə'maʊnt] (v)               | a totaliza                           | составлять                       |
| amuse [ə'mju:z] (v)                | a distra, a amuza                    | забавлять, развлекать            |
| ancestor ['ænsəstə] (n)            | strămoș, străbun                     | предок                           |
| ankle ['æŋkəl] (n)                 | gleznă                               | лодыжка                          |
| announce [ə'naʊns] (v)             | a anunța                             | объявлять                        |
| announcer [ə'naʊnsə] (n)           | crainic                              | диктор                           |
| anthem ['ænthəm] (n)               | imn                                  | гимн                             |
| antiquity [æn'tɪkwɪti] (n)         | antichitate                          | древность, античность            |
| anxiety [æŋ'zæti] (n)              | neliniște, îngrijorare               | беспокойство, тревога            |
| application [,æplɪ'keɪʃən] (n)     | cerere (scrisă)                      | заявление                        |
| appliqué [ə'plikɛ] (n)             | aplicație, dantelă                   | апликация                        |
| appoint [ə'pɔɪnt] (v)              | a numi (în funcție), a desemna       | назначать                        |
| appropriate [ə'prəʊpriət] (adj)    | potrivit                             | подходящий                       |
| aquiline ['ækwɪlɪn] (adj)          | (nas) acvilin, coroiat               | орлиный (нос)                    |
| area ['eəriə] (n)                  | arie, suprafață                      | площадь                          |
| argue ['ɑ:gju:] (n)                | a argumenta, a se certa              | доказывать, спорить              |
| arm ['ɑ:m] (n)                     | braț, mînă                           | рука (от кисти до плеча)         |
| arm-pit ['ɑ:m,pɪt] (n)             | subsuoară                            | подмышка                         |
| arrival [ə'raɪvəl] (n)             | sosire                               | прибытие                         |
| artificial [,ɑ:tɪ'fɪʃəl] (adj)     | artificial                           | искусственный                    |
| artisan [,ɑ:tɪ'zæn] (n)            | artizan, meșteșugar                  | ремесленник                      |
| artisanshîp [,ɑ:tɪ'zænʃɪp] (n)     | artizanat                            | художественное ремесло           |
| ash [æʃ] (n)                       | frasin                               | ясень                            |
| astounding [ə'stəʊndɪŋ] (adj)      | uluitor, uimitor                     | удивительный                     |
| attempt [ə'tempt] (v)              | a încerca                            | пытаться                         |
| attendance [ə'tendəns] (n)         | frecvență                            | посещаемость                     |
| audience ['ɔ:diəns] (n)            | spectatori, public, auditoriu        | аудитория, зрители               |
| auxiliary [ɔ:g'zɪliəri] (adj)      | auxiliar, ajutător                   | вспомогательный                  |

B

|                     |                  |            |
|---------------------|------------------|------------|
| badge ['bædʒ] (n)   | emblemă, insignă | значок     |
| baggy ['bægi] (adj) | lăbărat          | мешковатый |
| bake [beɪk] (v)     | a coace          | печь       |

|  |                                    |                              |
|--|------------------------------------|------------------------------|
| baking powder ['beɪkɪŋ 'paʊdə] (n)       | praf de copt                       | пекарный порошок             |
| baking sheet ['beɪkɪŋ 'ʃi:t] (n)         | tavă (de copt)                     | противень                    |
| bald [bɔ:ld] (adj)                       | chel, pleșuv                       | лысый, плешивый              |
| baptize [bæp'taɪz] (v)                   | a bateza                           | крестить                     |
| basement ['beɪsmənt] (n)                 | subsol, pivniță                    | подвальный этаж, подвал      |
| basil ['bæzəl] (n)                       | busuioc                            | базилик                      |
| beak [bi:k] (n)                          | cioc, plisc                        | клюв                         |
| beat [bi:t] (v)                          | a bate, a lovi                     | взбивать, ударять            |
| bed sheet ['bed 'ʃi:t] (n)               | cearșaf                            | простынь                     |
| bedding ['bedɪŋ] (n)                     | lenjerie de pat, așternut          | постельные принадлежности    |
| beef [bi:f] (n)                          | carne de vită                      | говядина                     |
| befriend [bi'frend] (v)                  | a se împrieteni                    | подружиться                  |
| behave [bi'hev] (v)                      | a se purta, a se comporta          | вести себя                   |
| ill-behaved (adj)                        | cu purtare rea                     | с плохим поведением          |
| bend [bend] (v)                          | a (se) îndoi, a (se) încovoia      | сгибать(ся), гнуть(ся)       |
| be on ['bi: 'ɔn] (phr v)                 | a prezenta un spectacol, a rula    | идти (о спектакле, фильме)   |
| berth [bɜ:θ] (n)                         | poliță-pat (în tren)               | спальное место (в поезде)    |
| betray [bi'treɪ] (v)                     | a trăda                            | предать, изменять            |
| betrayal [bi'treɪəl] (n)                 | trădare, înșelare                  | предательство, измена        |
| beverage ['bevərɪdʒ] (n)                 | băutură (preparată)                | напиток                      |
| bitter ['bɪtə] (adj)                     | amar                               | горький                      |
| blanket ['blæŋkɪt] (n)                   | cuvertură, pătură                  | одеяло                       |
| blazer ['bleɪzə] (n)                     | sacou                              | пиджак                       |
| bless [bles] (v)                         | a binecuvînta                      | благославлять                |
| blind [blaɪnd] (adj)                     | orb, nevăzător                     | слепой                       |
| blink [blɪŋk] (v)                        | a clipi (din ochi)                 | мигать, щуриться             |
| bluebell ['blu:bel] (n)                  | clopoțel (bot.)                    | колокольчик                  |
| blue tit ['blu:'tɪt] (n)                 | pițigoii                           | синица, лазоревка            |
| board [bɔ:d] (v)                         | a îmbarca, a se urca la bord       | сесть (на корабль)           |
| boarding school ['bɔ:dɪŋ 'sku:l] (n)     | școală cu internat                 | школа-интернат               |
| bobsled ['bɒbsled] (n)                   | sanie                              | санки, бобслей               |
| boil [bɔɪl] (v)                          | a fierbe                           | кипятить, варить             |
| book [bʊk] (v)                           | a rezerva bilete                   | заказывать                   |
| boring ['bɔ:ɪŋ] (adj)                    | plicticos, plictisitor             | скучный                      |
| bosom ['bʊzəm] (n)                       | sîn, piept                         | грудь                        |
| bowl [bəʊl] (n)                          | strachină, castron                 | миска                        |
| Braille [breɪl] (n)                      | scrierea Braille                   | шрифт Брайля (для слепых)    |
| bravery ['breɪvəri] (n)                  | curaj                              | храбрость                    |
| break out ['breɪk ,aʊt] (phr v)          | a izbucni, a începe                | разразиться                  |
| break up ['breɪk ,ʌp] (phr v)            | a se despărți, a se dispersa       | разрывать отношения          |
| breasts [breɪsts] (n)                    | sîni                               | грудь                        |
| breathe [bri:ð] (v)                      | a respira                          | дышать                       |
| brick house ['brɪk ,haʊs] (n)            | casă din cărămidă                  | кирпичный дом                |
| bride [braɪd] (n)                        | mireasă                            | невеста                      |
| bride-groom ['braɪdgru:m] (n)            | mire                               | жених                        |
| bridesmaid ['braɪdzmeɪd] (n)             | domnișoară de onoare               | подруга невесты              |
| broadcast ['brɔ:dkɑ:st] (n)              | emisiune (radio)                   | радиопередача                |
| brother-in-law ['brʌðəɪnlɔ:] (n)         | cumnat                             | шурин                        |
| bruise [bru:z] (v)                       | a zgîria, a juli, a face o vînație | царапать, подставлять синяки |
| brush up [ ,brʌʃ 'ʌp] (phr v)            | a perfecționa                      | усовершенствовать            |
| built-in wardrobe [ ,bɪltn'wɔ:drəʊb] (n) | dulap în perete                    | встроенный шкаф              |
| bunch [bʌntʃ] (n)                        | mănunchi, legătură, ciorchine      | пучок, гроздь                |
| bunk bed ['bʌŋk ,bed] (n)                | pat cu două nivele                 | койка (двухъярусная)         |
| burial ['beriəl] (n)                     | înmormîntare                       | похороны                     |



|   |                              |                                 |
|---|------------------------------|---------------------------------|
| bury ['beri] (v)                            | a îngropa, a înmormînta      | хоронить                        |
| bush [bʊʃ] (n)                              | tufiş, arbust                | куст                            |
| butcher ['bʊtʃə] (n)                        | măcelar                      | мясник                          |
| button ['bʌtn] (n)                          | nasture                      | пуговица                        |
| <b>C</b>                                    |                              |                                 |
| cabbage rolls ['kæbɪdʒ 'rəʊlz] (n)          | sarmale                      | голубцы                         |
| cabinet ['kæbɪnɪt] (n)                      | dulap                        | шкаф                            |
| calf [kɑ:f] (n)                             | pulpă, gambă (anat.)         | икра (ноги)                     |
| calm [kɑ:m] (adj)                           | calm, senin                  | спокойный                       |
| calmness ['kɑ:mnis] (n)                     | linişte, calmitate           | тишина, спокойствие             |
| cameraman ['kæmərəmæn] (n)                  | operator cinematografic      | кинооператор                    |
| commander-in-chief [,kə'mɑ:ndəɪn'tʃi:f] (n) | comandant suprem             | главнокомандующий               |
| compete [kəm'pi:t] (v)                      | a concura, a rivaliza        | соревновать(ся), конкурировать  |
| canary [kə'neəri] (n)                       | canar                        | канарейка                       |
| candid ['kændɪd] (adj)                      | sincer, onest, cinstit       | искренний, чистосердечный       |
| canned [kænd] (adj)                         | conservat                    | консервированный                |
| canoeing [kə'nu:ɪŋ] (n)                     | canotaj                      | каное                           |
| canvas ['kænvəs] (n)                        | pînză, canava; ţesătură      | холст; канва                    |
| canyon ['kænjən] (n)                        | canion                       | каньон, глубокое ущелие         |
| capture ['kæptʃə] (v)                       | a captura                    | захватить                       |
| care for ['keəfɔ:] (phr v)                  | a avea grijă de              | заботиться                      |
| caress [kə'res] (v)                         | a mîngîia, a dezmierda       | ласкать, гладить                |
| cargo ['kɑ:gəʊ] (n)                         | încărcătură                  | груз                            |
| carol ['kærəl] (n)                          | colind (ă)                   | коляда, колядка                 |
| carriage ['kæərɪdʒ] (n)                     | wagon, trăsură               | вагон, карета                   |
| cartoon film [kɑ:'tu:n 'fɪlm] (n)           | desen animat                 | мультфильм                      |
| carve [kɑ:v] (v)                            | a ciopli, a sculpta; a tăia  | резать, вырезать                |
| carry out [kæri 'aʊt] (phr v)               | a îndeplini                  | выполнять, доводить до конца    |
| catch up (with) [kætʃ 'ʌp] (phr v)          | a ajunge pe cineva din urmă  | догнать                         |
| cement [sɪ'ment] (n)                        | ciment                       | цемент                          |
| celebrate ['selɪbreɪt] (v)                  | a sărbători                  | праздновать                     |
| celebration [,selə'breɪʃən] (n)             | sărbătoare, celebrare        | празднование                    |
| ceremony ['serə'məni] (n)                   | ceremonie, solemnitate       | обряд, церемония                |
| challenge ['tʃæləndʒ] (n)                   | provocare, chemare           | вызов                           |
| channel [tʃænl] (n)                         | canal                        | канал, пролив                   |
| charity ['tʃærəti] (n)                      | caritate                     | милосердие, благотворительность |
| chart ['tʃɑ:t] (n)                          | tabelă, schemă, hartă marină | схема, таблица, морская карта   |
| cheat [tʃi:t] (v)                           | a înşela, a păcăli, a amăgi  | обманывать, мошенничать         |
| check [tʃek] (v)                            | a verifica, a controla       | проверять                       |
| check in [tʃek 'ɪn] (phr v)                 | a se înregistra              | регистрироваться                |
| check out [tʃek 'aʊt] (phr v)               | a achita cazarea la hotel    | выписаться (из гостиницы)       |
| checked ['tʃekt] (adj)                      | în carouri                   | клетчатый                       |
| cheerful ['tʃiəfʊl] (adj)                   | vesel, bine dispus, voios    | веселый, бодрый                 |
| chop [tʃɒp] (v)                             | a tăia bucăţi, a hăcui       | рубить, нарезать                |
| christen ['krɪsən] (v)                      | a boteza                     | крестить                        |
| christening ['krɪsənɪŋ] (n)                 | botezare; botez              | крещение                        |
| churchyard ['tʃɜ:ʃjɑ:d] (n)                 | cimitir, loc de veci         | кладбище, церковный двор        |
| cinema goer ['sɪnəmə 'gəʊə] (n)             | amator de cinema             | кинолюбитель                    |
| clay house ['kleɪ ,haʊs] (n)                | casă de lut                  | дом из глины                    |
| clear [kliə] (adj)                          | clar, luminos, senin         | ясный, светлый, чистый          |

clerk [kɪɑ:k] (n)  
 close friend [ˌkləʊs ˈfrend] (n)  
 closet ['klɒzɪt] (n)  
 clumsy ['klʌmzi] (adj)  
 coach [kəʊtʃ] (n)  
 coffee grinder ['kɒfi ˈgrændə] (n)  
 coffin ['kɒfɪn] (n)  
 cognitive ['kɒgnɪtv] (adj)  
 to collapse [kəˈlæps] (v)  
 communication [kə,mju:niˈkeɪʃən] (n)  
 compartment [kəmˈpɑ:tmənt] (n)  
 compassion [kəmˈpæʃən] (n)  
 composition [ˌkɒmpəˈzɪʃən] (n)  
 to comprehend [kəmprɪˈhænd] (v)  
 compulsory [kəmˈpʌlsəri] (adj)  
 computer [kəmˈpjʊ:tə] (n)  
 concrete house ['kɒŋkri:t ,haʊs] (n)  
 contain [kənˈteɪn] (v)  
 contest ['kɒntest] (n)  
 cooker ['kʊkə] (n)  
 coordinate [kəʊˈɔ:diːt] (v)  
 cosmopolitan [kɒzməˈpɒlɪtən] (n)  
 cotton ['kɒtn] (n)  
 couple ['kʌpəl] (n)  
 courage ['kʌrɪdʒ] (n)  
 courageous [kəˈreɪdʒəs] (adj)  
 course [kɔ:s] (n) *a course of*  
 cradle [kredl] (n)  
 craft [krɑ:ft] (n)  
 craftsman ['krɑ:ftsmən] (n)  
 cricket ['krɪkɪt] (n)  
 criticize ['krɪtɪsaɪz] (v)  
 crochet ['krəʊʃeɪ] (v)  
 crocus ['krɒkəs] (n)  
 crooked ['krʊkɪd] (adj)  
 crow [krəʊ] (n)  
 crown [kraʊn] (v)  
 crutch [krʌtʃ] (n)  
 cuisine [kwɪˈzi:n] (n)  
 cup [kʌp] (n)  
 curly ['kɜ:li] (adj)  
 curriculum [kəˈrɪkjʊləm] (n)  
 cut lessons [ˌkʌt ˈlesənz] (v)  
 cut out [kʌt ˈaʊt] (phr v)

## D

damage ['dæmɪdʒ] (v)  
 deaf [def] (adj)  
 deal with ['di:l wɪð] (phr v)  
 p. & p.p. dealt [delt]  
 debate [diˈbeɪt] (v)  
 decisive [diˈsɪsɪv] (adj)

funcționar  
 prieten apropiat  
 cămară  
 stîngaci, neîndemînic  
 antrenor  
 rîșniță de cafea  
 coșciug, sicriu  
 cognitiv  
 a cădea, a se prăbuși  
 comunicare  
 compartiment, cupeu  
 milă, compasiune  
 compoziție (de flori)  
 a înțelege  
 obligatoriu  
 calculator, computer  
 casă de beton  
 a conține, a include  
 întrecere, concurs  
 plită de gătit  
 a coordona  
 cosmopolit  
 bumbac, țesătură de bumbac  
 pereche, cuplu  
 curaj  
 curajos  
 ciclul de (lecții)  
 leagăn  
 meserie  
 meseriaș  
 crichet (sport)  
 a critica  
 a croșeta  
 brîndușă, șofran (bot.)  
 încovoiat, cocoșat, strîmb  
 cioară  
 a încorona  
 cîrjă  
 bucătărie (alimentație)  
 cupă, ceașcă  
 creț, ondulat  
 curriculum, program de studiu  
 a lipsi de la ore  
 a croi

a vătăma  
 surd  
 a avea de a face cu ceva/cineva  
 a polemiza  
 decisiv

клерк, чиновник  
 близкий друг  
 кладовая  
 неуклюжий, неловкий  
 тренер  
 кофемолка  
 гроб  
 познавательный  
 свалиться от болезни  
 связь, (со)общение  
 купе  
 жалость, сострадание  
 композиция (цветная)  
 понимать  
 обязательный  
 компьютер  
 дом из железобетонных блоков  
 содержать  
 соревнование  
 плита  
 согласовать  
 космополит  
 хлопок  
 пара  
 храбрость, смелость  
 смелый, отважный  
 курс (лекций)  
 колыбель  
 ремесло  
 мастер, ремесленник  
 крикет  
 критиковать  
 вязать крючком  
 шафран, крокус (бот.)  
 изогнутый, сгорбленный, кривой  
 ворона  
 короновать  
 костыль  
 кухня (питание)  
 кубок, чашка  
 кудрявый, волнистый  
 куррикулум, программа  
 пропускать уроки  
 вырезать, кроить

повреждать, ушибить  
 глухой, предназначать  
 иметь дело с чем-л./кем-л.

обсуждать  
 решающий

deck [dek] (n)  
 dedicate ['dediket] (v)  
 deep [di:p] (adj)  
 defeat [di'fi:t] (v)  
 deficiency [di'fiʃnsi] (n)  
 delay [di'lei] (v)  
 delegate ['deliget] (v)  
 deliberately [di'libərətli] (adv)  
 deliver [di'livə] (v)  
 depart [di'pɑ:t] (v)  
 departure [di'pɑ:tʃə] (n)  
 deprived [di'praɪvd] (adj)  
 design [di'zain] (v)  
 destination [,desti'neɪʃən] (n)  
 destroy [di'strɔɪ] (v)  
 devotion [di'vəuʃən] (n)  
 dimple ['dɪmpl] (n)  
 disability [,disə'bɪləti] (n)  
 disappear [,disə'piə] (v)  
 disappoint [,disə'pɔɪnt] (v)  
 disgusting [,dis'gʌstɪŋ] (adj)  
 dish [diʃ] (n)  
 dismiss [dis'mɪs] (v)  
 to display [di'spleɪ] (v)  
 device [di'vais] (n)  
 divide [di'vaɪd] (v)  
 doorknob ['dɔ:nɒb] (n)  
 dot [dɒt] (n)  
 double bed [ˌdʌbəl 'bed] (n)  
 double-deck bed [ˌdʌbəl 'dek bed] (n)  
 doubt [daʊt] (n)  
 dough [daʊ] (n)  
 dove [dɒv] (n)  
 to doze [dɔuz] (v)  
 dozen ['dʌzn] (n)  
 draughts [dra:fts] (n)  
 drawer [dra:] (n)  
 dubbing ['dʌbɪŋ] (n)  
 dumb [dʌm] (adj)  
 durable ['djʊərəbəl] (adj)  
 dye [daɪ] (v) (n)

punte  
 a dedica  
 profund  
 a învinge, a înfringe  
 deficiență  
 a amîna, a întîrzia  
 a delega, a încredința  
 intenționat, dinadins  
 a furniza  
 a pleca  
 plecare  
 lipsit de  
 a proiecta; a destina  
 destinație  
 a distruge  
 devotament  
 gropiță (în obraz)  
 incapacitate, neputință  
 a dispărea  
 a dezamăgi, a decepționa  
 desgustător, răspingător, scîrbos  
 veselă, fel de mîncare  
 a concedia, a elibera  
 a expune, a prezenta, a manifesta  
 dispozitiv  
 a împărți  
 mîner (la ușă)  
 punct  
 pat dublu  
 pat în două nivele  
 îndoială  
 aluat  
 porumbel  
 a moțai, a dormi ușor  
 duzină, doisprezece  
 joc de dame  
 sertar  
 dublare, dublaj  
 mut  
 durabil  
 a vopsi, vopsea

палуба  
 посвящать  
 глубокий  
 наносить поражение  
 недостаток  
 откладывать, опаздывать  
 уполномочивать  
 умышленно  
 доставлять  
 уезжать, уходить  
 отправление  
 лишенный  
 проектировать  
 место назначения  
 разрушать  
 преданность  
 ямочка (на щеке)  
 неспособность, нетрудоспособность  
 исчезать  
 разочаровать  
 отвратительный  
 посуда, блюдо  
 увольнять, отпускать, освобождать  
 показывать, выставлять  
 прибор  
 разделять  
 дверная ручка  
 точка  
 двуспальная кровать  
 двухъярусная кровать  
 сомнение  
 тесто  
 голубь  
 дремать  
 дюжина  
 шашки  
 выдвижной ящик  
 дублирование (фильма)  
 немой  
 прочный  
 красить, краска

**E**

eagle ['i:gl] (n)  
 educator ['edʒəkertə] (n)  
 egg white ['eg waɪt] (n)  
 egg yolk ['eg jɒk] (n)  
 elbow ['elbəʊ] (n)  
 embrace [ɪm'breɪs] (v)  
 embroider [ɪm'brɔɪdə] (v)  
 empathy ['empəθi] (n)  
 employ [ɪm'plɔɪ] (v)

vultur  
 educator  
 albuș de ou  
 gălbenuș de ou  
 cot  
 a îmbrățișa  
 a broda  
 empatie  
 a angaja (personal, în serviciu)

орел  
 воспитатель  
 яичный белок  
 яичный желток  
 локоть  
 обнимать  
 вышивать  
 сочувствие  
 нанимать, предоставлять работу

|   |   |  |
|---|---|--|
| <p>employed [ɪm'plɔɪd] (adj)<br/> employment [ɪm'plɔɪmənt] (n)<br/> to enable [ɪ'neɪbl] (v)<br/> end in a draw (phr)<br/> endure [ɪn'dʒʊə] (v)<br/> engage [ɪn'ɡeɪdʒ] (v)<br/> engagement [ɪn'ɡeɪdʒmənt] (n)<br/> enjoyable [ɪn'dʒɔɪəbəl] (adj)<br/> enquiry office [ɪn'kwɪəri 'ɒfɪs] (n)<br/> entertainment [ˌentə'teɪnmənt] (n)<br/> environment [ɪn'vaɪənmənt] (n)<br/> equator [i'kwetə] (n)<br/> equip [ɪ'kwɪp] (v)<br/> equipment [ɪ'kwɪpmənt] (n)<br/> even ['i:vən] (v)<br/> execution [ˌeksɪ'kju:ʃn] (n)<br/> expect [ɪk'spekt] (v)<br/> expel [ɪk'spel] (v)<br/> expensive [ɪk'spensɪv] (adj)<br/> experienced [ɪk'spɪəriənst] (adj)<br/> express [ɪk'spres] (n)<br/> extract (food) [ɪ'ekstrækt] (n)</p> | <p>angajat<br/> ocupație<br/> a da posibilitate de a<br/> a termina o partidă la egalitate<br/> a îndura, a răbda<br/> a angaja, a năimi, a logodi<br/> logodnă<br/> plăcut, frumos<br/> informație, birou/ghișeu de informație<br/> distracție<br/> mediu ambiant<br/> ecuator<br/> a înzestra, a echipa, a utiliza<br/> utilaj<br/> a egaliza (un scor)<br/> execuție<br/> a aștepta, a se aștepta<br/> a elimina, a exclude<br/> scump, costisitor<br/> cu experiență; calificat<br/> (tren) expres, rapid<br/> esență</p> | <p>служащий<br/> занятие<br/> давать возможность<br/> заканчивать вничью<br/> выносить, терпеть<br/> нанимать, обручиться<br/> помолвка<br/> приятный, доставляющий удовольствие<br/> справочная, справочное бюро<br/> развлечение<br/> окружающая среда<br/> экватор<br/> снаряжать, оборудовать<br/> оборудование<br/> равнять (счет)<br/> казнь<br/> ожидать, надеяться<br/> исключать<br/> дорогостоящий<br/> опытный, знающий<br/> скорый (поезд)<br/> экстракт, эссенция</p> |
|---|---|--|

## F

|   |   |   |
|---|---|---|
| <p>to facilitate [fə'sɪlɪteɪt] (v)<br/> fabric ['fæbrɪk] (n)<br/> fancy ['fænsɪ] (n)<br/> fame [feɪm] (n)<br/> fasten ['fɑ:sən] (v)<br/> fat [fæt] (adj)<br/> father-in-law ['fɑ:ðərɪnlɔ:] (n)<br/> fault [fɔ:lt] (n)<br/> favour, in favour of [ɪn 'feɪvərəv] (phr)<br/> fearless ['fi:lɪs] (adj)<br/> feelings ['fi:lɪŋz] (n)<br/> fencing ['fensɪŋ] (n)<br/> ferry ['feri] (n)<br/> fiancé [ˌfi:ɑ:n'seɪ] (n)<br/> fiancée [ˌfi:ɑ:n'seɪ] (n)<br/> fibre [faɪbə] (n)<br/> fierce ['fiəs] (adj)<br/> fire [faɪə] (v)<br/> fist [fɪst] (n)<br/> flat [flæt] (adj)<br/> flat footed [ˌflæt 'fʊtɪd] (adj)<br/> fleet [fli:t] (n)<br/> flour ['flaʊə] (n)<br/> flowerbed ['flaʊəbed] (n)<br/> focus ['fəʊkəs] (v)<br/> forearm ['fɔ:ɑ:m] (n)<br/> fore parent [fɔ: 'peərənt] (n)<br/> foreigner ['fɔrɪnə] (n)</p> | <p>a facilită, a înlesni<br/> țesătură<br/> frumos<br/> glorie<br/> a încheia, a fixa<br/> gras, plin<br/> socru<br/> greșală<br/> în favoarea<br/> neînfricat<br/> sentimente<br/> scrimă<br/> feribot<br/> logodnic<br/> logodnică<br/> fibră<br/> aspru<br/> a trage cu arma, a împușca<br/> pumn<br/> plat, întins<br/> cu picior plat<br/> flotă<br/> făină<br/> strat/răzor de flori<br/> a concentra<br/> antebraț<br/> strămoș, străbun<br/> străin</p> | <p>облегчать<br/> ткань<br/> красивый<br/> известность, слава<br/> привязывать, прикреплять<br/> полный, упитанный<br/> свекор, тесть<br/> ошибка<br/> в пользу<br/> бесстрашный<br/> чувства, ощущения<br/> фехтование<br/> паром<br/> жених<br/> невеста<br/> волокно, ткань<br/> суровый<br/> стрелять, вести огонь<br/> кулак<br/> плоский, ровный<br/> плоскостопный<br/> флот<br/> мука<br/> клуба<br/> сосредоточивать(ся)<br/> предплечье<br/> предок<br/> иностранец</p> |
|---|---|---|

|  |  |  |
|--|--|--|
| <p>forgive [fə'gɪv] (n)<br/> former ['fɔ:mə] (adj)<br/> fresh [freʃ] (adj)<br/> friendless ['frendlɪs] (adj)<br/> fry [fraɪ] (v)<br/> frying pan ['fraɪɪŋ,pæn] (v)<br/> full-time [,fʊl'taɪm] (adj) (adv)</p>  | <p>a ierta<br/> fost, anterior,<br/> proaspăt<br/> fără prieteni<br/> a prăji<br/> tigaie<br/> zi de lucru deplină</p>   | <p>прощать<br/> бывший, прежний<br/> свежий<br/> одинокий<br/> жарить<br/> сковорода<br/> полный рабочий день</p>  |
| <b>G</b>   |  |  |
| <p>gain [geɪn] (v)<br/> garlic juice ['gɑ:lɪk ,dʒu:s] (n)<br/> garment ['gɑ:mənt] (n)<br/> garnish ['gɑ:nɪʃ] (v)<br/> gateway ['geɪtweɪ] (n)<br/> gather ['gæðə] (v)<br/> general education<br/> ['dʒenərəl ,edʒu'keɪʃən] (n)<br/> get together ['get tə'geðə] (v)<br/> to giggle ['gɪg(ə)] (v)<br/> ginger ['dʒɪndʒə] (adj)<br/> godchild ['gɒd,tʃaɪld] (n)<br/> godfather ['gɒd ,fɑ:ðə] (n)<br/> godparents ['gɒd ,peərənts] (n)<br/> Good Friday [,gʊd 'frɑ:di] (n)<br/> government ['gʌvənmənt] (n)<br/> graceful ['greɪsful] (adj)<br/> graceless ['greɪslɪs] (adj)<br/> grade [greɪd] (n) (Am.)<br/> graduate ['grædʒjuət] (n)<br/> grave [ɡreɪv] (n)<br/> gravy ['ɡreɪvɪ] (n)<br/> grease [ɡri:s] (v)<br/> grieve [ɡri:v] (<i>about, at, for</i>) (phr v)<br/> grill [ɡrɪl] (n)<br/> gown [ɡaʊn] (n)<br/> guilty ['ɡɪltɪ] (adj)<br/> gymnasium [dʒɪm'neɪzɪəm] (n)</p> | <p>a câștiga<br/> mujdei<br/> îmbrăcămintе<br/> a garnisi, a împodobi<br/> intrare<br/> a strînge, a aduna<br/> studii medii<br/> <br/> a (se) aduna, a (se) întruni<br/> a chicoti, a se hlizi<br/> culoare roșcată/brun roșcat<br/> fin, fină<br/> naș<br/> nași<br/> Vinerea Mare<br/> guvern<br/> grațios, elegant<br/> lipsit de grație, stîngaci<br/> clasă<br/> absolvent, licențiat<br/> mormînt<br/> zeamă/suc de carne, sos de friptură<br/> a unge (cu grăsimе)<br/> a se întrista<br/> grătar<br/> rochie (lungă, de seară)<br/> vinovat<br/> gimnaziu</p> | <p>достигать, добиваться<br/> чесночный соус<br/> одежда<br/> украшать, отделывать<br/> ворота<br/> собирать, скоплять<br/> среднее образование<br/> <br/> встречаться, собираться<br/> хихикать<br/> рыжеватый цвет (волос)<br/> крестник, крестница<br/> крестный отец<br/> крестные родители<br/> Святая Пятница перед Пасхой<br/> правительство<br/> грациозный, изящный<br/> некрасивый, непривлекательный<br/> класс<br/> выпускник<br/> могила<br/> подливка (из сока жаркого), соус<br/> смазывать<br/> огорчаться, горевать<br/> рашпер<br/> платье (вечернее)<br/> виновен<br/> гимназия</p> |
| <b>H</b>   |  |  |
| <p>habitual [hə'bitʃuəl] (adj)<br/> hammer ['hæmə] (n)<br/> hammer nails (v)<br/> handicap ['hændɪkæp] (n)<br/> hand in [,hænd'in] (phr v)<br/> handsome ['hænsəm] (adj)<br/> harbour ['hɑ:bə] (n)<br/> hard [hɑ:d] (adj)<br/> hard-working ['hɑ:dwɜ:kɪŋ] (adj)<br/> harmful ['hɑ:mfʊl] (adj.)<br/> harsh [hɑ:ʃ] (adj.)<br/> haughty ['hɔ:ti] (adj)<br/> hawk [hɔ:k] (n)</p>   | <p>obișnuit, comun; curent<br/> ciocan<br/> a bate cuie<br/> handicap<br/> a înmîna<br/> frumos, chipeș<br/> port<br/> vîrtos, tare, dur<br/> harnic, muncitor, silitor<br/> dăunător, periculos<br/> sever<br/> mîndru, arogant<br/> șoim</p>   | <p>привычный, обычный<br/> молоток<br/> забивать гвозди<br/> физический недостаток<br/> вручать<br/> красивый<br/> гавань, порт<br/> твердый, жесткий<br/> трудолюбивый<br/> вредный, опасный<br/> строгий<br/> гордый<br/> ястреб</p>   |

|  |   |  |
|--|---|--|
| <p>head-master [ˌhedˈmɑːstə] (n)<br/> head-mistress [ˌhedˈmɪstrəs] (n)<br/> heater [ˈhiːtə] (n)<br/> heel [hiːl] (n)<br/> highland [ˈhaɪlənd] (n)<br/> hockey stick [ˈhɒkɪˌstɪk] (n)<br/> hoist [hɔɪst] (v)<br/> hold [həʊld] (v)<br/> home-made [ˌhəʊmˈmeɪd] (adj)<br/> honey-moon [ˈhɒnɪmuːn] (n)<br/> honour [ˈɒnə] (n)<br/> hooded [ˈhʊdɪd] (adj)<br/> hook [hʊk] (n)<br/> house, stone house [ˈstəʊnˌhaʊs] (n)<br/> hub [hʌb] (n)<br/> humour [ˈhjuːmə] (n)</p>   | <p>director de școală<br/> directoare de școală<br/> încălzitor, cămin<br/> călcii, toc (la încălțăminte)<br/> regiune muntoasă<br/> crosă<br/> a ridica<br/> a ține, a organiza<br/> de casă, lucrat/făcut în casă<br/> lună de miere<br/> cinste, onoare<br/> cu glugă<br/> cîrlig<br/> casă de piatră<br/> fig. centru<br/> umor</p>   | <p>директор школы<br/> директриса<br/> нагревательный прибор<br/> пятка, каблук<br/> горная местность<br/> клюшка<br/> поднимать<br/> проводить<br/> домашнего изготовления<br/> медовый месяц<br/> честь, почести<br/> с капюшоном<br/> крючок<br/> каменный дом<br/> центр деятельности<br/> юмор</p>  |
| <b>I</b>   |   |  |
| <p>idiom [ˈɪdɪəm] (n)<br/> to ignore [ɪˈɡnɔː] (v)<br/> illness [ˈɪlnəs] (n)<br/> improvement [ɪmˈpruːvmənt] (n)<br/> include [ɪnˈkluːd] (v)<br/> index [ˈɪndeks] (n)<br/> industrious [ɪnˈdʌstriəs] (adj)<br/> ineffective [ɪnɪˈfektɪv] (adj)<br/> influence [ˈɪnfluəns] (v)<br/> ingredient [ɪnˈɡrɪːdɪənt] (n)<br/> inhabit [ɪnˈhæbɪt] (v)<br/> inherit [ɪnˈherɪt] (v)<br/> install [ɪnˈstɔːl] (v)<br/> integrate [ˈɪntɪɡreɪt] (v)<br/> interpreter [ɪnˈtɜːprɪtə] (n)<br/> iron [ˈaɪən] (n)<br/> ironing [ˈaɪənɪŋ] (n)<br/> irresponsible [ɪrɪˈspɒnsəbəl] (adj)</p> | <p>expresie idiomatică, idiomă<br/> a ignora<br/> boală<br/> îmbunătățire, perfecționare<br/> a include, a cuprinde<br/> arătător (deget), index<br/> harnic, silitor, vrednic<br/> fără rezultat, neefectiv<br/> a influența<br/> ingredient, parte componentă<br/> a locui, a popula<br/> a moșteni<br/> a instala<br/> a integra, a alcătui, a constitui<br/> interpret, translator<br/> fier de călcat<br/> călcat, călcare (cu fierul)<br/> iresponsabil</p> | <p>идиома<br/> игнорировать<br/> болезнь<br/> улучшение, усовершенствование<br/> включать, заключать<br/> указательный палец<br/> трудолюбивый, усердный<br/> безрезультатный<br/> влиять<br/> ингредиент, составная часть<br/> населять<br/> (у)наследовать<br/> устанавливать<br/> составлять целое<br/> переводчик (устный)<br/> утюг, железо<br/> глажение, утюжка<br/> безответственный</p> |
| <b>J</b>   |   |  |
| <p>jog [dʒɒɡ] (v)<br/> jolly [ˈdʒɒli] (adj)<br/> joyous [ˈdʒɔɪəs] (adj)<br/> jubilation [ˈdʒuːbɪˈleɪʃən] (n)<br/> jubilee [ˈdʒuːbiːliː] (n)<br/> juicy [ˈdʒuːsi] (adj)<br/> justify [ˈdʒʌstɪfaɪ] (v)</p>   | <p>a alerga încet<br/> bine dispus, vesel<br/> vesel, voiois<br/> jubilar<br/> jubileu<br/> suculent<br/> a justifica, a motiva</p>   | <p>бегать трусцой<br/> веселый, радостный<br/> веселый, радостный<br/> празднование<br/> юбилей<br/> сочный<br/> оправдывать</p>   |
| <b>K</b>   |   |  |
| <p>kick [kɪk] (v)<br/> knee [niː] (n)</p>  | <p>a lovi cu piciorul<br/> genunchi</p>   | <p>ударять ногой<br/> колени</p>   |

|  |   |   |
|--|---|---|
| knitting needles ['nɪtɪŋ 'ni:dɪz] (n)          | andrele, ace de tricatat                  | спицы для вязания                         |
| knitwear ['nɪtweə] (n)                         | tricotaj                                  | трикотажные изделия                       |
| knuckle ['nʌkəl] (n)                           | articulație a degetelor                   | сустав пальца                             |
| <b>L</b>                                       |   |   |
| lace [leɪs] (n)                                | dantelă; șiret                            | кружево; шнурок                           |
| lack (of) ['læk(ə)] (n)                        | lipsă (de)                                | недостаток (чего-либо)                    |
| ladle [leɪdl] (n)                              | polonic, lingură mare                     | половник                                  |
| lamb [læm] (n)                                 | miel, carne de miel                       | барашек/ягненок                           |
| lark [lɑ:k] (n)                                | ciocîrlie                                 | жаворонок                                 |
| lasting ['lɑ:stɪŋ] (adj)                       | de durată lungă                           | длительный                                |
| lasting friendship<br>['lɑ:stɪŋ 'frendʃɪp] (n) | prietenie trainică (de durată)            | крепкая дружба                            |
| lawn ['lɔ:n] (n)                               | peluză                                    | газон, лужайка                            |
| lawyer ['lɔ:jə] (n)                            | avocat                                    | адвокат                                   |
| lay the table ['leɪ ðə 'teɪbl] (phr)           | a pune masa, a așterne masa               | накрывать на стол                         |
| lend a hand ['lendə 'hænd] (phr)               | a da o mână de ajutor                     | помогать, протянуть руку помощи           |
| leprechaun ['leprə'kɔ:n] (n)                   | spiriduș (în folclorul irlandez)          | эльф                                      |
| liar ['liə] (n)                                | minciunos                                 | обманщик                                  |
| lie [li:] (v)                                  | a minți                                   | обманывать                                |
| liking ['lɪkɪŋ] (n)                            | preferință                                | симпатия                                  |
| lime [laɪm] (n)                                | 1. var; 2. tei (bot.); lămiie verde       | 1. известь; 2. липа; разновидность лимона |
| linden ['lɪndən] (n)                           | tei (bot.)                                | липа                                      |
| linen ['lɪnɪn] (n)                             | pînză (de in); albituri, lenjerie         | полотно, холст; белье                     |
| liner ['laɪnə] (n)                             | navă, transatlantic                       | пассажирский пароход или самолет          |
| little finger ['lɪtl 'fɪŋgə] (n)               | degetul mic                               | мизинец                                   |
| live [laɪv] (adj) (programme)                  | pe viu, în direct (emisiune)              | (здесь) прямая трансляция                 |
| loaf [ləʊf] (n)                                | franzelă, pîine (de anumită formă)        | буханка                                   |
| long-legged ['lɒŋlegd] (adj)                   | înalt, cu picioare lungi                  | длинноногий                               |
| look after [lʊk'ɑ:ftə] (phr v)                 | a avea grijă                              | присматривать, заботиться                 |
| loose [lu:s] (adj.)                            | larg (haină)                              | широкий (об одежде)                       |
| lowland ['ləʊlənd] (n)                         | șes                                       | низкая местность                          |
| <b>M</b>                                       |   |   |
| magpie ['mægpəɪ] (n)                           | coțofană                                  | сорока                                    |
| maintain [men'teɪn] (v)                        | a menține, a susține, a întreține         | поддерживать                              |
| make a film ['meɪkə'fɪlm] (phr)                | a produce un film                         | снимать фильм                             |
| manage ['mænɪdʒ] (v)                           | a conduce, a minui, a dirija              | руководить, управлять                     |
| manufacture [,mænjʊ'fæktʃə] (v)                | a fabrica, a confecționa                  | производить, фабриковать                  |
| maple ['meɪpəl] (n)                            | arțar                                     | клён                                      |
| marvelous ['mɑ:vələs] (adj)                    | minunat, uimitor, extraordinar            | удивительный, изумительный                |
| mastery ['mɑ:stəri] (n)                        | perfectiune                               | мастерство, совершенство                  |
| measure ['meʒə] (n)                            | măsură                                    | мерка, мера                               |
| measurement ['meʒəmənt] (n)                    | măsurare, măsură                          | измерение                                 |
| meet [mi:t] (v)                                | a satisface                               | удовлетворять                             |
| membership ['membəʃɪp] (n)                     | comunitate, societate, calitate de membru | членство                                  |
| mental [mentl] (adj)                           | mintal, intelectual                       | умственный                                |
| middle-finger ['mɪdlfɪŋgə] (n)                 | deget mijlociu                            | средний палец                             |
| mind [maɪnd] (v)                               | a fi atent la, a nu uita                  | помнить, заботиться                       |
| miss the train ['mɪs ðə 'treɪn] (phr)          | a întârzia la tren                        | опоздать на поезд                         |

|  |   |  |
|--|---|--|
| <p>mother-in-law ['mʌðərɪnlɔ:] (n)<br/> mould [məʊld] (v)<br/> mountaineering [ˌmaʊntɪˈneɪɪŋ] (n)<br/> muscle ['mʌsəl] (n)<br/> mutton [ˈmʌtɪn] (n)</p>  | <p>soacră<br/> a modela<br/> alpinism<br/> muşchi<br/> carne de oaie</p>  | <p>свекровь, теща<br/> моделировать<br/> альпинизм<br/> мышца<br/> баранина</p>  |
| <b>N</b>   |   |  |
| <p>nail [neɪl] (n)<br/> narrow ['nærəʊ] (adj)<br/> naval [neɪvəl] (adj)<br/> navigable ['nævɪgəbəl] (adj)<br/> network ['netwɜ:k] (n)<br/> newsreel ['nju:zri:l] (n)<br/> nightingale ['naɪtɪŋgeɪl] (n)<br/> noodles [nu:dlz] (n)<br/> nurse [nɜ:s] (n)</p>  | <p>unghie, cui<br/> îngust, limitat<br/> naval, de marină, marin<br/> navigabil<br/> rețea<br/> jurnal de actualități<br/> privighetoare<br/> țâiței<br/> soră medicală; dădacă</p>   | <p>ноготь; гвоздь<br/> узкий, тесный<br/> морской, флотский<br/> судоходный<br/> сеть<br/> хроника, киножурнал<br/> соловей<br/> лапша (домашняя)<br/> няня; мед. сестра</p>   |
| <b>O</b>   |   |  |
| <p>obstruct [əb'strʌkt] (v)<br/> one way ticket (n)<br/> opt for ['ɒpt fɔ:] (phr v)<br/> outfit ['aʊtfɪt] (n)<br/> outfitter ['aʊtfɪtə] (n)<br/> outstanding [aʊt'stændɪŋ] (adj.)<br/> oven ['ʌvən] (n)</p>  | <p>a bloca<br/> bilet pentru o călătorie<br/> a opta, a se decide pentru<br/> set de haine<br/> magazin de haine (furnizor)<br/> remarcabil<br/> cuptor</p>   | <p>заграждать<br/> билет в одно направление<br/> решить(ся) на<br/> комплект одежды<br/> магазин готовой одежды<br/> известный<br/> печь</p>   |
| <b>P</b>   |   |  |
| <p>pace [peɪs] (v)<br/> palm [pɑ:m] (n)<br/> part-time [ˌpɑ:t 'tʌm] (adj)<br/> pass on [pɑ:s 'ɒn] (phr v)<br/> pastry brush ['peɪstri 'brʌʃ] (n)<br/> pat [pæt] (v)<br/> path [pɑ:θ] (n)<br/> patience ['peɪʃns] (n)<br/> pattern ['pætən] (n)<br/> pattern pieces ['pætən 'pi:si:z] (n)<br/> peel [pi:l] (v)<br/> peer [piə] (n)<br/> permanent ['pɜ:mənənt] (adj)<br/> pet [pet] (v)<br/> pickle(s) ['pɪkəl(z)] (n)<br/> pictures ['pɪktʃəz] (n)<br/> picturesque [ˌpɪktʃə'resk] (adj)<br/> pie [paɪ] (n)<br/> pierce [piəs] (v)<br/> pile [paɪl] (v)<br/> pillowcase ['pɪləʊkeɪs] (n)<br/> pity ['pɪti] (n)<br/> plait [plæt] (v)</p> | <p>a păși, a se plimba<br/> palmă<br/> zi incompletă de muncă<br/> a trece (clasa)<br/> perie de uns tava<br/> a bate ușor cu palma pe umăr<br/> cărare<br/> răbdare, îngăduință<br/> model<br/> tipar (pentru croit)<br/> a curăța, a decoji<br/> persoană de o vîrstă<br/> permanent, stabil<br/> a răsfăța, a mîngia, a dezmerda<br/> murătură, murături<br/> cinema<br/> pitoresc<br/> plăcintă, tartă<br/> a străpunge<br/> a îngrămădi, a aduna<br/> față de pernă<br/> compătîmire, compasiune<br/> a împleti în cosițe; a împleti</p> | <p>шагать<br/> ладонь<br/> неполный (рабочий день)<br/> переходить (класс)<br/> кисть для смазывания противней<br/> похлопывать кого-либо по плечу<br/> тропинка<br/> терпение<br/> образец, пример<br/> выкройки<br/> чистить, снимать кожицу<br/> ровестник<br/> постоянный<br/> ласкать<br/> соленья, соленья<br/> кино<br/> живописный<br/> пирог, пирожок<br/> пронзать<br/> складывать<br/> наволочка<br/> сострадание, сожаление<br/> заплетать; плести</p> |



|   |  |  |
|---|--|--|
| <p>plumber ['plʌmə] (n)<br/> pork [pɔ:k] (n)<br/> porthole ['pɔ:thəʊl] (n)<br/> poster ['pəʊstə] (n)<br/> poultry ['pəʊltrɪ] (n)<br/> pour [pɔ:] (v)<br/> to preheat [pri:'hi:t] (v)<br/> previous ['pri:vɪəs] (adj)<br/> print [prɪnt] (v)<br/> printing ['prɪntɪŋ] (n)<br/> processing [prə'sesɪŋ] (n)<br/> produce a film (phr. v)<br/> [prə'dju:s ə 'fɪlm]<br/> proficiency [prə'fɪʃənsi] (n)<br/> promote [prə'məʊt] (v)<br/> protect [prə'tekt] (v)<br/> provide [prə'vaɪd] (v)<br/> pull [pʊl] (v)<br/> purchase ['pɜ:tʃəs] (v)<br/> purpose ['pɜ:pəs] (n)<br/> purposeful ['pɜ:pəsful] (adj)<br/> purposeless ['pɜ:pəsɪs]<br/> push [pʊʃ] (v)</p>           | <p>instalator (de apă și canal)<br/> carne de porc<br/> ferestruică (în avion, corabie)<br/> poster, afiș<br/> carne de pasăre, păsări domestice<br/> a turna, a vărsa<br/> a preîncălzi<br/> anterior, precedent<br/> a tipări<br/> tipar<br/> proces de prelucrare<br/> a ecraniza, a turna un film</p> <p>competență, experiență<br/> a promova, a susține<br/> a proteja, a apăra<br/> a asigura<br/> a trage<br/> a cumpăra, a căpăta<br/> scop<br/> avînd un scop, hotărît, intenționat<br/> inutil<br/> a împinge</p> | <p>водопроводчик<br/> свинина<br/> иллюминатор<br/> плакат, объявление<br/> курица (мясо), домашняя птица<br/> лить, вливать<br/> подогревать<br/> предыдущий<br/> печатать<br/> печатание, тираж<br/> обработка (материала)<br/> поставить кинокартину</p> <p>опытность, умение<br/> повышать, содействовать<br/> защищать<br/> обеспечивать<br/> тянуть<br/> покупать, приобрести<br/> намерение, цель<br/> целеустремленный, умышленный<br/> бесцельный, бесполезный<br/> толкать</p>   |
| <b>Q</b>  |  |  |
| <p>quail [kweɪl] (n)<br/> quarrel ['kwɔrəl] (v)</p>   | <p>prepeliță<br/> a se certa</p>   | <p>перепел<br/> ссориться</p>  |
| <b>R</b>  |  |  |
| <p>racket ['ræktɪ] (n)<br/> railing ['reɪlɪŋ] (n)<br/> rainfall ['reɪnfɔ:l] (n)<br/> rainforest ['reɪnfɔrɪst] (n)<br/> raven ['reɪvən] (n)<br/> reception [rɪ'sepʃən] (n)<br/> recipe ['resəpi] (n)<br/> recollect [,rekə'lekt] (v)<br/> recruit [rɪ'kru:t] (v)<br/> reduce [rɪ'dju:s] (v)<br/> referee [ˌrefə'ri:] (n)<br/> regain ['ri'geɪn] (v)<br/> reliable [rɪ'laɪəbəl] (adj)<br/> to rely [rɪ'laɪ] (v)<br/> to rely on [rɪ'laɪ ɒn] (phr. v)<br/> remind [rɪ'maɪnd] (v)<br/> replace [rɪ'pleɪs] (v)<br/> reporting [rɪ'pɔ:tɪŋ] (n)<br/> require [rɪ'kwaɪə] (v)<br/> requirement [rɪ'kwaɪəmənt] (n)<br/> research [rɪ'sɜ:tʃ] (v)<br/> resign [rɪ'zaɪn] (v)</p> | <p>rachetă (de tenis)<br/> balustradă<br/> cantitate de precipitații<br/> pădure tropicală<br/> corb<br/> primire, recepție<br/> rețetă<br/> a-și aminti<br/> a recruta<br/> a reduce, a coborî<br/> arbitru<br/> a recăpăta, a recîștiga<br/> demn de încredere<br/> a se bizui<br/> a se bizui pe<br/> a aminti<br/> a înlocui, a schimba cu locul<br/> prezentare<br/> a cere, a solicita<br/> cerință, condiție de bază<br/> a cerceta, a investiga<br/> a demisiona</p>   | <p>ракетка (теннисная)<br/> перила, ограда<br/> кол-во осадков<br/> тропический лес<br/> ворон<br/> прием<br/> рецепт<br/> вспоминать, припоминать<br/> вербовать, набирать (в армию)<br/> понижать, уменьшать<br/> спортивный судья<br/> вновь приобрести, получить обратно<br/> надежный, прочный<br/> полагаться, доверять<br/> полагаться на, доверять кому-либо<br/> напоминать<br/> заменять<br/> отчет, доклад<br/> требовать, нуждаться<br/> требование, необходимое условие<br/> исследовать<br/> подать в отставку</p> |

|  |  |   |
|--|--|---|
| <p>restrict [rɪ'strɪkt] (v)<br/> return ticket [rɪ'tɜ:n] (n)<br/> reveal [rɪ'vi:l] (v)<br/> revive [rɪ'vaɪv] (v)<br/> rim [rɪm] (v)<br/> ring finger ['rɪŋ,fɪŋgə] (n)<br/> ripe [raɪp] (adj)<br/> roast [rəʊst] (n)<br/> robin ['rɒbm] (n)<br/> rock [rɒk] (n)<br/> rough [rʌf] (adj)<br/> rustle ['rʌsəl] (v)</p>   | <p>a limita, a interzice<br/> bilet dus-întors<br/> a dezvălui, a descoperi<br/> a reinvia, a renaște<br/> a înconjura<br/> deget inelar<br/> copt, matur<br/> friptură<br/> prihor, măcăleandru<br/> rocă, stîncă<br/> aspru, brutal<br/> a tremăta, a murmura</p>  | <p>ограничивать, запрещать<br/> обратный билет<br/> открывать<br/> возродить, оживлять<br/> окружать<br/> безымянный палец<br/> спелый, зрелый<br/> жаркое<br/> малиновка (птица)<br/> скала<br/> грубый, невежливый<br/> шелестеть, шуршать</p>  |
| <b>S</b>   |  |   |
| <p>sacrifice ['sækrɪfɪs] (n)<br/> safety-belt ['seɪfti belt] (n)<br/> sake [seɪk], for the sake of (phr)<br/> salesman ['seɪlzmən] (n)<br/> schedule ['ʃedju:l] (n)<br/> scientist ['saɪəntɪst] (n)<br/> scold [skəʊld] (v)<br/> score [skɔ:] (v)<br/> score the victory ['skɔ: ðə 'vɪktəri] (phr)<br/> scratch [skrætʃ] (v)<br/> sculpt [skʌlpt] (v)<br/> sculpture ['skʌlptʃə] (n)<br/> second course [,sekənd 'kɔ:s] (n)<br/> selfish ['selfɪ] (adj)<br/> sensitive ['sensətɪv] (adj)<br/> sentence ['sentəns] (v)<br/> serve the ball ['sɜ:v ðə 'bɔ:l] (phr)<br/> settlement ['setlmənt] (n)<br/> set up (records) [set 'ʌp ('rekɔ:dz)] (phr v)<br/> sew [səʊ] (v)<br/> share [ʃeə] (v)<br/> shift [ʃɪft] (n)<br/> shin [ʃɪm] (n)<br/> shoulder ['ʃəʊldə] (n)<br/> to ship [ʃɪp] (v)<br/> shipping ['ʃɪpɪŋ] (n)<br/> showy ['ʃəʊi] (adj)<br/> sieve [sɪv] (n)<br/> sift [sɪft] (v)<br/> silk [sɪlk] (n)<br/> single ['sɪŋgəl] (adj)<br/> sister-in law ['sɪstərm,lɔ:] (n)<br/> skilful [s'kɪlful] (adj)<br/> skilled [skɪld] (adj)<br/> slender ['slendə] (adj)<br/> slice [slaɪs] (n)<br/> slight [slaɪt] (adj)<br/> slim [slɪm] (adj)<br/> to slip ['slɪp] (v)<br/> slotted-spoon ['slɒtɪd ,spu:n] (n)</p> | <p>sacrificiu<br/> centură de siguranță<br/> de dragul<br/> vînzător<br/> orar<br/> savant<br/> a mostra, a certa, a dojeni<br/> scor, golaveraj; a marca<br/> a câștiga<br/> a zgîria, a juli<br/> a sculpta<br/> sculptură<br/> felul doi<br/> egoist<br/> sensibil, firav<br/> a condamna<br/> a servi mingea<br/> stabilire (cu traiul)<br/> a stabili (recorduri)<br/> a coase<br/> a împărtași, a împărți<br/> schimb<br/> fluierul piciorului<br/> umăr<br/> a transporta<br/> expediere, flotă comercială<br/> arătos, important<br/> sită<br/> a cerne<br/> mătase<br/> singur; bilet pentru o (singură) călătorie<br/> cumnată<br/> dibaci<br/> calificat, priceput<br/> zvelt, suplu<br/> felie, bucată<br/> zvelt, subțire<br/> zvelt<br/> a aluneca<br/> spumieră</p> | <p>жертва, жертвоприношение<br/> ремень безопасности<br/> ради<br/> продавец<br/> расписание<br/> ученый<br/> бранить (ся)<br/> счет; открыть счет, забивать<br/> забить победный гол<br/> царапаться, чесаться<br/> ваять<br/> скульптура<br/> второе блюдо<br/> эгоист<br/> чувствительный<br/> приговаривать, осуждать<br/> подавать мяч<br/> поселение<br/> устанавливать (рекорды)<br/> шить, шивать<br/> делиться, разделять<br/> рабочая смена<br/> голень<br/> плечо<br/> перевозить<br/> торговый флот<br/> эффективный, яркий<br/> сито<br/> просеивать<br/> шёлк<br/> одинокий; билет в один конец<br/> невестка<br/> искусный<br/> квалифицированный, искусный<br/> тонкий, стройный<br/> ломтик<br/> тонкий, хрупкий<br/> тонкий, стройный<br/> скользить<br/> шумовка</p> |

smell [smel] (n)  
 snack [snæk] (n)  
 sneeze [sni:z] (v)  
 snub [snʌb] (adj)  
 soft [sɒft] (adj)  
 sole [səʊl] (n)  
 sorrow ['sɒrəʊ] (n)  
 sour [saʊə] (adj)  
 to sow [səʊ] (v)  
 sparrow ['spærəʊ] (n)  
 species ['spi:ʃi:z] (n)  
 spectrum ['spektrəm] (n)  
 speechless ['spi:tʃləs] (adj)  
 spice [spaɪs] (n)  
 spouse [spaʊz] (n)  
 sprain [sprɛɪn] (v)  
 sprinkle ['sprɪŋkəl] (v)  
 sprint [sprɪnt] (n)  
 squeezer ['skwi:zə] (n)  
 lemon squeezer (n)  
 status ['steɪtəs] (n)  
 steak [steɪk] (n)  
 step [step] (v)  
 step-mother ['stepmʌðə] (n)  
 stopover ['stɒp,əʊvə] (n)  
 stir [stɜ:ɪ] (v)  
 stitch [stɪtʃ] (n) (v)  
 a storm of applause  
 [ə 'stɔ:m əv ə'plɔ:z] (n)  
 stove; gas stove ['gæs ,stəʊv] (n)  
 straight [streɪt] (adj)  
 style [stɑɪl] (v)  
 surfing ['sɜ:ʃɪŋ] (n)  
 surrender [sə'rendə] (v)  
 surround [,sə'raʊnd] (v)  
 swallow ['swɒləʊ] (n)  
 swan [swɒn] (n)  
 to sweat [swet] (v)  
 sweat shirt ['swet ,ʃɜ:t] (n)  
 sweeper ['swi:pə] (n)  
 switch on [,swɪtʃ 'ɒn] (phr. v)  
 switch off [,swɪtʃ 'ɒf] (phr. v)

## T

tablecloth ['teɪbəlklɒθ] (n)  
 tableware ['teɪbəlweə] (n)  
 tailor ['teɪlə] (n)  
 take care of [,teɪk 'keəɪv] (phr. v)  
 take off [teɪk 'ɒf] (phr. v)  
 tank top ['tæŋk ,tɒp] (n)  
 tapestry ['tæprɪstri] (n)  
 teaching staff ['ti:tʃɪŋ stɑ:f] (n)  
 tease [ti:z] (v)  
 technique [tek'ni:k] (n)

miros  
 gustare  
 a strănuta  
 (nas) cîrn  
 moale  
 talpă  
 durere, regret, necaz  
 acru  
 a semăna  
 vrăbie  
 specie, soi, rasă  
 spectru  
 mut, amuțit, uluit  
 condiment  
 soț, soție  
 a scrinti, a luxa  
 a stropi, a presăra  
 sprint  
 storcător  
 storcător de lămii  
 statut (situație)  
 biftec, cotlet, antricot  
 a păși  
 mamă vitregă  
 escală  
 a amesteca  
 tiv / a tivi  
 furtună de aplauze  
 plită; aragaz  
 drept, neted  
 a aranja (părul)  
 surf(ing)  
 a capitula, a se da bătut  
 a înconjura  
 rîndunică  
 lebedă  
 a transpira  
 sveter de bumbac  
 măturător  
 a aprinde, a da drumul  
 a stinge, a opri

запах, обоняние  
 закуска  
 чихать  
 курносый  
 мягкий, нежный  
 подошва  
 печаль, горе, скорбь  
 кислый  
 сеять  
 воробей  
 вид, порода, разновидность  
 спектр  
 немой, безмолвный, онемевший  
 специя, пряность  
 супруг, супруга  
 растянуть связки  
 брызгать, посыпать  
 спринт, бег на короткие дистанции  
 выжималка  
 выжималка для лимона  
 статус (положение)  
 бифштекс, кусок (мяса для поджаривания)  
 шагать  
 мачеха  
 остановка (в пути)  
 размешивать  
 шов / строчить  
 взрыв аплодисментов  
 плита; газовая плита  
 прямой, неизогнутый  
 укладывать волосы  
 серфинг  
 сдавать(ся), капитулировать  
 окружать, обступать  
 ласточка  
 лебедь  
 потеть  
 хлопковый свитер  
 подметальщик  
 включать  
 выключать

față de masă  
 veselă și tacîmuri  
 croitor  
 a avea grijă de  
 a decola, a-și lua zborul  
 vestă fără mînci  
 tapiserie, goblen  
 corp didactic  
 a necăji, a sicii  
 metodă

скатерть  
 посуда, вилки, ложки  
 портной  
 ухаживать за  
 взлететь  
 безрукавка  
 затканная от руки материя, goblen  
 учительский коллектив  
 дразнить, приставать  
 метод/способ

|                                       |                               |                                    |
|---------------------------------------|-------------------------------|------------------------------------|
| tender ['tendə] (adj)                 | gingaș, plăpînd, tandru       | нежный, хрупкий                    |
| tendon ['tendən] (n)                  | tendon (anat.)                | сухожилие                          |
| thigh [θaɪ] (n)                       | coapsă, pulpă                 | бедро                              |
| to thread a needle (phr. v)           | a băga ață în ac              | продеть нитку в иглоку             |
| [tə 'θred ə 'ni:dl]                   |                               |                                    |
| thrilling ['θrɪlɪŋ] (adj)             | emoționant                    | волнующий                          |
| thumb [θʌm] (n)                       | degetul mare                  | большой палец                      |
| thus [ðʌs] (adv)                      | astfel, așa                   | так, таким образом                 |
| tight [taɪt] (adj.)                   | îngust (haină)                | узкий (об одежде)                  |
| tinned [tɪnd] (adj)                   | conservat                     | консервированный                   |
| tip [tɪp] (n)                         | capăt                         | конец                              |
| tiptoe ['tɪptəʊ] (v)                  | a merge în virful picioarelor | ходить на цыпочках                 |
| toboggan [tə'bɒgən] (n) (v)           | sanie; a se da cu sania       | санки; кататься на санках          |
| toe [təʊ] (n)                         | deget de la picior            | палец ноги                         |
| touch [tʌtʃ] (v)                      | a atinge                      | дотрагиваться                      |
| tournament ['tʊənəmənt] (n)           | competiție sportivă, turnir   | турнир, спортивные состязания      |
| toy chest ['tɔɪ ,tʃest]               | ladă pentru jucării           | ящик для игрушек                   |
| trade [treɪd] (n)                     | comerț                        | торговля                           |
| traitor ['treɪtə] (n)                 | trădător                      | предатель                          |
| translator [træns'leɪtə, trænz -] (n) | traducător, translator        | переводчик                         |
| treasure ['treɪzə] (n)                | comoară, avere                | сокровище                          |
| treat [tri:t] (v)                     | a trata                       | лечить                             |
| triangular dumpling                   | colțunaș                      | вареник                            |
| [traɪ'æŋgju:lə 'dʌmpling] (n)         |                               |                                    |
| trifling ['traɪflɪŋ] (adj)            | neînsemnat, mărunț            | пустячный, нестоящий               |
| to trim ['trɪm] (v)                   | a tunde                       | стричь                             |
| triplet ['trɪplət] (n)                | trigemeni                     | тройня                             |
| trouble ['trʌbl̩] (n)                 | necaz                         | горе, беда                         |
| to be in trouble (phr. v)             | a avea un necaz               | быть в беде                        |
| true friend ['tru: ,frend] (n)        | prieten adevărat              | настоящий друг                     |
| trust [trʌst] (n)                     | încredere                     | доверие                            |
| trust in [trʌst 'ɪn] (phr v)          | a avea încredere              | доверять                           |
| tuner ['tju:nə] (n)                   | reglare, acord, acordor       | настройщик, музыкант               |
| tunic ['tju:nɪk] (n)                  | tunică                        | туника                             |
| turn on [tɜ:n 'ɒn] (phr v)            | a porni, a aprinde (lumina)   | включать (свет), открывать (кран)  |
| turn off [tɜ:n 'ɒf] (phr v)           | a opri, a stinge (lumina)     | выключать (свет), закрывать (кран) |
| twins [twɪnz] (n)                     | gemeni                        | близнецы                           |
| twist [twɪst] (v)                     | a suci, a contorsiona         | скручивать                         |
| type [taɪp] (v)                       | a tipări                      | печатать на машинке                |
| typist ['taɪpɪst] (n)                 | dactilograf                   | машинистка                         |
| <b>U</b>                              |                               |                                    |
| ugly ['ʌgli] (adj)                    | urît, neatrăgător             | безобразный, неприятный            |
| unemployed [,ʌnɪm'plɔɪd] (adj)        | șomer                         | безработный                        |
| unfriendly [ʌn'frendli] (adj)         | neprietenos, dezagreabil      | недружелюбный                      |
| up-to-date [ʌp tə 'deɪt] (adj)        | modern, la modă               | современный, новейший              |
| urbanization ['ɜ:bə ,nʌɪzəʃn] (n)     | urbanizare                    | урбанизация                        |
| <b>V</b>                              |                               |                                    |
| valuable ['væljuəbəl] (adj)           | valoros, prețios              | ценный, дорогой                    |
| view [vju:] (n)                       | priveliște, vedere; opinie    | вид; мнение                        |
| viewer ['vju:ə] (n)                   | spectator, privitor           | зритель                            |

|                                   |                                 |                                    |
|-----------------------------------|---------------------------------|------------------------------------|
| vinegar ['vɪnɪɡə] (n)             | oțet                            | уксус                              |
| visual aid [,vɪʒuəl 'eɪd] (n)     | material didactic (auxiliar)    | наглядное пособие                  |
| vocational [vəʊ'keɪʃənəl] (adj)   | profesional, de meserie         | профессиональный                   |
| <b>W</b>                          |                                 |                                    |
| watch over [ˌwɒtʃ 'əʊvə] (phr v)  | a proteja, a feri               | охранять                           |
| water skiing ['wɔ:tə ,ski:ɪŋ] (n) | schii de apă                    | воднолыжный спорт                  |
| wavy ['weɪvɪ] (adj)               | ondulat                         | волнистый                          |
| weave [wi:v] (v)                  | a țese, a croșeta, a împleti    | ткать, плести                      |
| wedding ['wedɪŋ] (n)              | cununie, nuntă                  | венчание, свадьба                  |
| weight lifting ['weɪt,lɪftɪŋ] (n) | haltere, ridicare de greutate   | тяжелая атлетика, поднятие тяжести |
| whisk [wɪsk] (n)                  | tel                             | сбивалка                           |
| wide [waɪd] (adj)                 | larg, mare                      | широкий                            |
| widow ['wɪdəʊ] (n)                | văduvă                          | вдова                              |
| widower ['wɪdəʊə] (n)             | văduv                           | вдовец                             |
| window box ['wɪndəʊ bɒks] (n)     | jardinieră, ghiveci             | горшок для цветов                  |
| window sill ['wɪndəʊ sɪl] (n)     | pervaz                          | подоконник                         |
| wink [wɪŋk] (v)                   | a clipi, a face cuiva din ochi  | моргать, подмигивать               |
| winner ['wɪnə] (n)                | învingător, câștigător          | победитель                         |
| wood (house) [wud] (adj)          | de/din lemn                     | деревянный                         |
| wood carving ['kɑ:vɪŋ] (n)        | sculptură în lemn               | резьба по дереву                   |
| woodland ['wudlənd] (n)           | ținut împădurit; păduri         | лесистая местность; лес            |
| wool [wʊl] (n)                    | lână                            | шерсть, руно                       |
| work-out ['wɜ:k ,aʊt] (n)         | antrenament                     | тренировка                         |
| worry ['wɒrɪ] (v)                 | a se neliniști, a-și face griji | беспокоиться                       |
| wound [wu:nd] (v)                 | a răni                          | ранить                             |
| wrestling ['reslɪŋ] (n)           | lupte greco-romane/corp la corp | спортивная борьба                  |
| wrist [rɪst] (n)                  | încheietura mîinii              | запястье                           |
| <b>Y</b>                          |                                 |                                    |
| yachting ['jɒtɪŋ] (n)             | iahting, navigare, călătorie    | парусный спорт                     |
| yeast [ji:st] (n)                 | drojdie                         | дрожжи                             |

# English for You and Me

**English for You and Me** is a course designed for Form 7. The course meets the requirements of the National Curriculum.

## English for You and Me

- develops reading, writing and speaking skills;
- builds an extensive vocabulary;
- provides a large diversity of activities to develop language skills;
- develops fluency through integrated skills work;
- develops pupils' intellectual curiosity.

Components at each level:

Pupil's Book

Teacher's Book

Class Cassette

ISBN 978-9975-54-214-2



9 789975 542142